

When happiness or calamity is about to come,
said Confucius, it can be known
beforehand. Insure complete
radio happiness with

Grebe Receiver

Doctor Mu.

IF YOU buy inferior radio apparatus
you must not expect the best
results.

Its long record of satisfactory service has won for the Grebe Receiver the unqualified endorsement of all experienced radioists and dealers.

Your copy of "Musings of Doctor Mu" sent free upon request.

A. H. GREBE & CO., INC.
RICHMOND HILL, N.Y.

Licensed under
Armstrong U. S.
Pat. No. 1113149

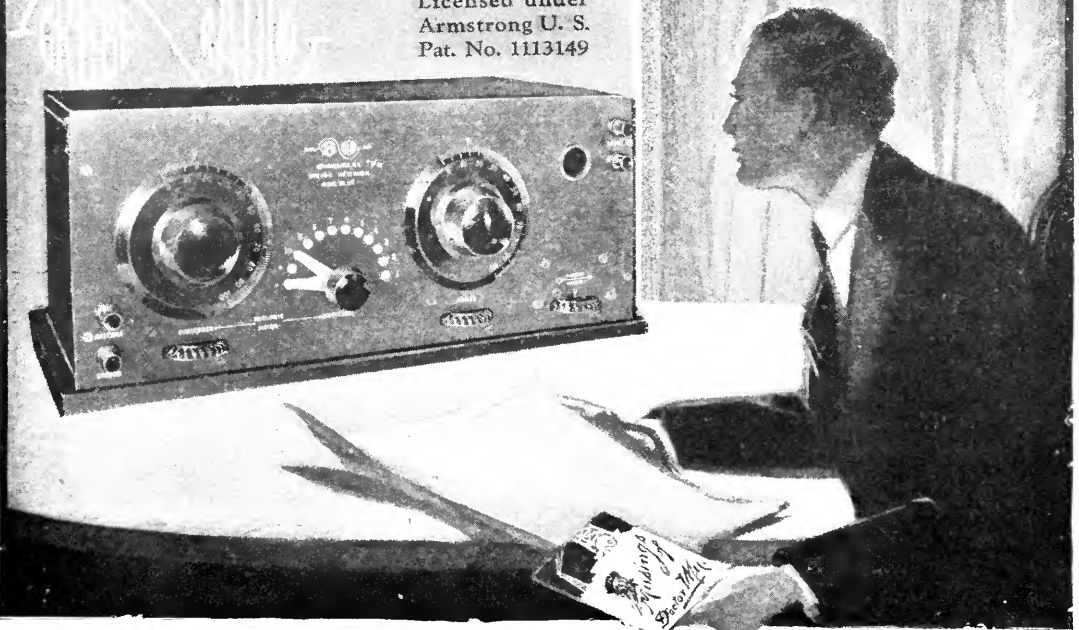



ICE FROM HEAD TO FOOT

It is at such stations as this that a lighthouse-keeper learns the value of a home-made receiving set for brightening the lonely hours. This is the Racine Reef Light Station on Lake Michigan

RADIO BROADCAST

Vol. 2 No. 5



March, 1923

The March of Radio

MONOPOLIZING PRODUCTION OF APPARATUS

WITH the almost innumerable patents which have been issued for radio circuits and appliances during the last decade it was a foregone conclusion that turmoil and strife were soon due for those undertaking the manufacture and sale of radio apparatus. It would be difficult to point to one piece of radio apparatus, or even a detail of that piece, which is not covered by a patent of some sort. The wise manufacturer is obliged to call to his aid the services of a shrewd patent attorney if he is to make anything to do with radio and "get away with it."

Of course there are a few basic patents which seem to hold water and serve as an effectual deterrent to those not owning, or operating under, the patent licenses. Thus the manufacture of ordinary vacuum tubes at present is apparently a risky undertaking for any one not operating under license from the Radio Corporation; the manufacture of regenerative sets is feasible only for those operating under license from the Radio Corporation or those who acquired an Armstrong license before the patent was sold to the Radio Corporation. Even the Radio Corporation occasionally has to contend with some patent trouble. We understand that the present tubes with their elliptical plates and grids have been given that peculiar shape in order to "get by" a patent covering a cylindrical construction

of vacuum tubes. The use of a grid leak is patented. The use of a grid biasing-battery is patented. In fact, the complete radio set involves literally scores of patents.

It is now nearly prohibitive for any but a few "inside" firms to manufacture a good radio receiving set; a new company trying to break into the game and make a good set finds that to acquire licenses and pay the royalties demanded requires so much money that they could not manufacture and market a set at a profit. We understand that a short time ago a firm desiring to manufacture regenerative sets was asked \$35,000 cash and \$15 a set royalty for the privilege. Other patents would require their royalties also, so that naturally a set put together under such restrictions must cost the customer a lot if the manufacturer is to get any profit at all.

There are about a score of firms which have been making regenerative sets under Armstrong licenses. They have apparently been more or less immune from patent troubles. These firms acquired their licenses for practically nothing before the Radio Corporation got control of it. It seems now, however, that the situation is to be made somewhat more difficult for them. The A. H. Grebe Co., one of the better known radio manufacturers, is now being sued for infringement of five different patents owned by the Radio Corporation—patents issued to De Forest, Langmuir, Lowenstein, and Mathes over a period reaching from

1907 to 1922, these patents covering tubes and circuits for using tubes.

Should the injunction which is sought by the Radio Corporation be granted, it seems that every manufacturer of radio apparatus in the country would be put out of business—excepting, of course, the Radio Corporation itself. It seems that a monopoly of the most grinding sort is the object of this firm. The resulting situation might not be reckoned as a monopoly by that corporation because it seems that head telephone sets might possibly still be manufactured, although even that might prove to be covered.

To give some idea of the scope and nature of the injunction sought by the Radio Corporation, we quote a part of one sentence of the plaintiff's bill, as affecting the De Forest patents. In one paragraph of the complaint on which the Radio Corporation bases its prayer to the Court, it appears that the defendant, said A. H. Grebe Co. ". . . did unlawfully and wrongfully make . . . wireless receiving sets adapted, designed, and intended for use in combination with, and useful only in combination with, vacuum detector and amplifier tubes."

If the defendant should be enjoined from radio set manufacture on a complaint of this kind, the radio monopoly would be even more stringent than is that covering the manufacture of tungsten lamps to-day. We recall the testimony of one of the General Electric officials, recently given in some case involving lamp manufacture, that the General Electric Company did not have a monopoly of the lamp industry, because they controlled only 99 and a fraction per cent. of the product. This will be about the situation in the radio field should the plaintiff's prayer be granted.

A radio set must necessarily be used in combination with a detector, crystal or tube, and evidently all radio apparatus, be it coil, condenser, or what-not, is "intended for use in combination with" either tube or crystal. Hence the owner of the crystal and tube patents could control everything in the radio field. They might even start suit against the wire manufacturers who manufacture radio cable (litzendraht) as it is evidently intended for use in radio sets which are used in combination with tubes! And every high-resistance head telephone set is evidently intended for use with either a crystal or tube, so why not sue the telephone manufacturer into the bargain?

And the Bakelite Corporation might also receive the attention of the Radio Corporation because it evidently markets much of its product "to be used in combination with vacuum-tube detectors and amplifiers."

All of which means endless conflict and general dissatisfaction. However, there is a way out of these conditions, and RADIO BROADCAST will suggest, next month, lines along which this conflict and this dissatisfaction may be avoided.

The New Method of Reproducing Speech

IT IS often impossible for speakers of importance to make and keep engagements to appear in person at the broadcasting stations, with the result that the ability of the speakers engaged for the radio audiences is not always as high as it might be. We cannot expect that the Chief Executive or his cabinet officers will appear at broadcasting stations frequently, yet we should be much interested to hear them express their views on the topics of the day. We have elected them to office and are entitled to hear them express, first hand, not through reporters, their views on those questions in the settlement of which their influence will be decisive.

One of the great defects in our representative scheme of government is the very slight relations between our elected officers and those who elected them. After seeing the prospective office holders and hearing them, face to face, make promises of what they are going to do if elected, the average voter never again hears the voice of the man he helped to office, and generally has but little knowledge of what he is doing to carry out the promises he made. What a remarkable situation would arise if we could call upon those we have elected to give an occasional accounting of their activities—say once monthly. When an important question arose the elected officer would be called upon to express, publicly and personally, over the radio, his stand and reasons therefor. Many of us would soon know more about the way our government functions, and take more interest in it, than we do now.

The heads of departments of any commercial organization are required to have personal interviews with the chief who appointed them to their positions; why shouldn't our appointees, our representatives and senators, regularly report to us on their activities so that we may

continually be informed as to whether or not they are doing what they promised to do when they asked for our votes? The prospect is a very interesting one, and it seems that the electorate would be much more conscientiously served if advantage could be taken of its possibilities. We are reminded of the progress of communication by radiophone in the Navy. By its use, the admiral is able to hold the officers to a much more exact observance of orders, with no excuse due to fault in communications—the admiral is able to talk directly to the commanders of the various vessels and so can know that his orders are perfectly understood by the whole fleet. That is just the kind of control the electorate would like to exercise over their chosen servants, and it may be that the radiophone will help in this as it has done in the Navy.

Any step in this direction, making closer the contact between important business men or office holders, and those to whom their views are of especial interest, is to be welcomed. There has been developed in the laboratories of the General Electric Co. a device which promises to be an important factor in improving this branch of radio broadcasting, styled the pallophotophone. With this euphonious title the sponsors have decided to christen a new photographic method of recording and reproducing speech or music, which has apparently been developed along somewhat different lines from any other method of which we have heard.

There is apparently no new scientific principle involved in the scheme; it is an ingenious combination of pieces of apparatus which had not been tried before. There can be but few really new discoveries or fundamental inventions with the present rate of progress of science;

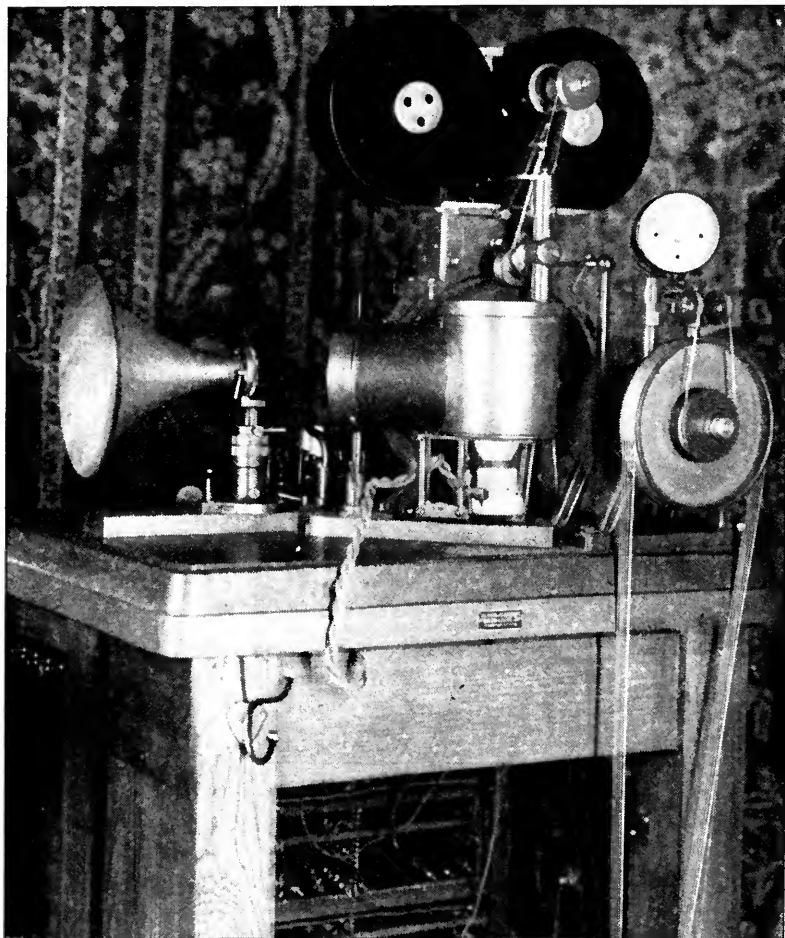

AS CLEAR AS THE HUMAN VOICE

This is the claim for the speech reproduced by Charles A. Hoxie's pallophotophone, the remarkable combination of inventions by which sounds are photographed on a moving film and changed to corresponding electric currents which may be used, at any time, to control the output of a broadcasting station

most inventions must be merely an improvement on devices already known or new combinations of these devices. Such is the pallophotophone, for which Mr. Charles A. Hoxie, of the General Electric Co., a well known inventor, seems to be responsible.

This scheme of Hoxie's involves, first, photographing sounds on a moving film by means of a vibrating diaphragm, suitable magnifying levers, and a mirror, and secondly, changing this record on the film by a photo-electric cell to corresponding electric currents which, sent through amplifiers, are able to control the output of the broadcasting station. Both of the actions involved in the pallophotophone have really been developed in university laboratories by so-called "pure" scientists;



MAJOR-GENERAL JAMES G. HARBORD

Who succeeded Edward J. Nally as President of the Radio Corporation of America, on January 1st. He is a former Rough Rider, a veteran of the war in Cuba and the Philippines, was Chief of Staff under General Pershing in France, and later commanded the Marine Brigade of the Second Division at Belleau Wood, Boursesches, and Château-Thierry. In 1918, he commanded the Service of Supply which was responsible for all supplies of the A. E. F.

so far as we know it was not necessary for Hoxie to do much investigation of the action of either the recorder principle or the reproducer principle, but it undoubtedly did require a deal of ingenuity and skill to make them operate properly in a piece of commercial apparatus.

To Professor Miller of the Case School of Applied Science is due the credit for the pioneer work in recording sound waves by the use of suitably mounted small mirrors. His book giving the results of this pioneer work makes fascinating reading and is illustrated with many remarkable photographs of the sound waves from various instruments.

The photo-electric cell has been a subject of inquiry, during the last few years, for many able investigators; an explanation of its action, it seemed, might throw much light on the nature of electromagnetic waves as well as on the structure of the molecule. Even as we

are writing this, there has just arrived a valuable contribution to the theory and action of photo-electric cells by two of the research workers of the Western Electric laboratories. A photo-electric cell is essentially a two-electrode vacuum tube, one of the electrodes being such a metal as potassium or sodium. If the other electrode is made positive with respect to the potassium, an electron current will flow to it from the potassium whenever the latter is illuminated. The light wave impinging on the surface of the potassium is apparently able to pull out some electrons, which, once through the surface of the potassium, go over to the positive electrode. The number of electrons set free by this so-called photo-electric action, is proportional to the intensity of the light, so that if a light of variable intensity is thrown on the surface of the potassium, the electron current to the anode will correspondingly vary.

In the pallophotophone Hoxie has been able to coordinate the work of Miller and that on photo-electricity to create a wonderful sound-recording and reproducing mechanism. By making the mirrors, levers, and diaphragm of extremely small mass, the oscillating light beam sent off from the mirror actually follows even the high-frequency consonant sounds of the voice. The record looks like a black line about one quarter of an inch wide, one side of which has a serrated appearance, due to the peaks of the sound wave reaching out past the edge of the black line. With loud sounds, the pointed projections from the edge of the black line are comparatively long, looking like a lot of fine needle points about one eighth of an inch long, the needle points being at right angles to the edge of the black line. With high pitched sounds the needle points are close together, and with bass notes they are much farther apart.

In the reproducing scheme, light shines through this strip of film on to a photo-electric cell; according to the number and size of the serrations on the edge of the black line, a varying amount of light falls on the sensitive cell and so a varying current flows through it. This current goes to the amplifiers and on to the control circuit of the broadcast transmitter.

According to those who have heard the reproduction, it is excellent. On several occasions WGY has operated with the pallophotophone film as the voice control and the listeners have been under the impression that the speaker was in the studio of the station. Evi-

dently a device as good as this one seems to be, may prove of great importance in the development of the talking movie.

Interference from Arc Stations

THE highest-powered transmitting stations in the world to-day use the Poulsen arc as the source of high-frequency power for the antenna. A high-voltage, continuous-current generator supplies power to a very intense arc, burning in a closed, water-cooled chamber filled with illuminating gas or alcohol vapor. When suitable connections are made between this arc and the antenna, part of the continuous-current power supply, perhaps 40%, is changed into high-frequency power and fed to the antenna. The scheme is good only for long-wave stations. This method for generating high-frequency power is used at practically all the government's high-power stations as well as some smaller commercial stations on the west coast.

Unfortunately, these arcs generate other frequencies than those desired for operating the station, some of them high enough to be heard by stations listening on wavelengths perhaps one tenth that used by the arc station. This extra power, at the higher frequencies, is undesirable both from the standpoint of efficiency and interference, and attempts have frequently been made to eliminate it. That the schemes are not quite as successful as the arc advocates would have us believe is shown by the following extract from a letter sent by one of our correspondents.

"—Permit me to relate that any one living in this city or within a radius of more than fifteen miles, possibly farther, has very discouraging difficulties to overcome in the line of interference from two very powerful government stations located at the Mare Island Navy yard—interference from the 100, 30, and 12-kilowatt arc stations at that place commonly referred to as "mush." One or more of these powerful arc stations is in almost constant operation during broadcast hours."

The Amateurs and Professionals

FOR a considerable period this winter the amateurs of America and Europe carried out tests to see how consistently communication on the 200-meter wavelength, with low-powered transmitting sets, could be estab-



©Underwood & Underwood

EDWARD J. NALLY

Who was President of the Radio Corporation from the time it was founded until January of this year. He has now taken up the duties of his new post as Managing Director of International Relations for the Radio Corporation, with offices in Paris. Mr. Nally, who has been in communication business all his life, has been a prominent figure in the development of radio in this country, and because of his familiarity with conditions abroad is especially qualified to represent the growing interests in the foreign field

lished. It seems remarkable how many of the American amateurs have been heard in Europe, stations from as far west even as the Pacific coast having been copied on the other side of the Atlantic. Altogether, between one hundred and two hundred stations were successful in spanning the ocean. From the latest reports available, European transmitters have not been so successful in crossing the ocean from east to west—just why is not yet apparent.

We have always considered short waves as entirely unsuited for long distance communication. In fact it seems, from some of the accepted formulas of radio, as though a two-hundred-meter wave would be so attenuated in its two thousand miles of travel that even an excellent receiving set would be unable to detect it. The accepted equations for wave propagation have been based on experimental data and of course the data may have been unreliable in the short-wave range. Marconi,

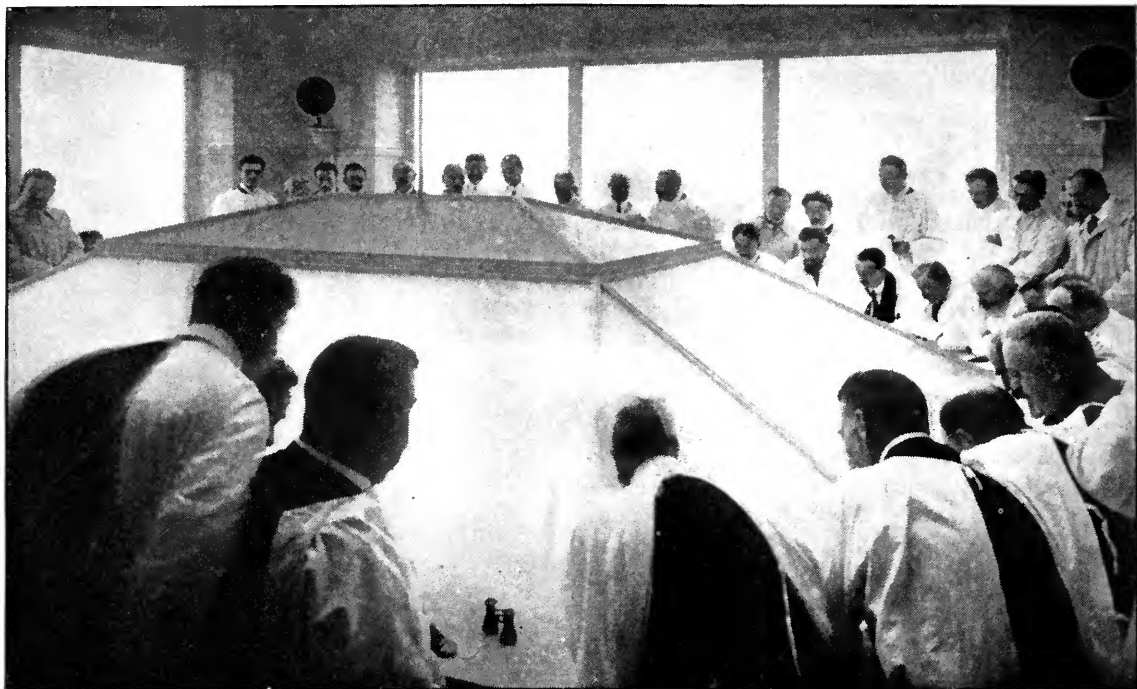

A MODERN SURGICAL CLINIC IN PARIS

Doctors and students at St. Michel view the operations through this glass dome, and hear the slightest sounds in the room below, including the comments of the operating surgeons, by means of a microphone installation. Two loud-speaking horns may be seen at the far side of the room

during his most recent visit, gave the results of short-wave transmission in England, showing that it was possible to telephone over a hundred miles with waves much shorter than those used by the average amateur.

A difficulty encountered with short-wave transmission is that of sufficient radiation. With the small antennas necessarily used for tuning to the short wavelength it is at present impossible to radiate much power. It is not apparent to-day that it will ever be possible to send out several hundred kilowatts on 200 meters, but if continued experimentation shows that the attenuation is much less than has been supposed, some scheme will probably be found for operating a whole series of antennas synchronously so that the radiation from each is in the right phase to assist that of all the others. When such developments come, directional radio will be much nearer of accomplishment than it now is; a whole set of small antennas, properly operating at 200 meters, would send practically all their power in one direction, a beam of radiation perhaps ten degrees wide.

It seems strange that the powerful radio-

phone stations of the commercial companies are scarcely ever heard on the other side of the Atlantic. Only occasionally do we get reports of WJZ or WEAJ being heard in Europe. Certainly in this country these professional stations reach greater distances than do most amateurs, and we should naturally suppose they would span the ocean much more effectively than the short-wave amateur stations. It is not at all evident, however, that this is the case. We may yet find that the short wave is much more suitable for long-distance transmission than we have heretofore supposed.

Again the National Radio Chamber of Commerce

THE formation of this body was commented upon some time ago. Its functions, as expressed in the circulars sent out by the organizers, were to be many and varied, among them being the regulation of the activities of broadcasting stations. The Chamber announces that, after conferences with the Navy Department, Department of Commerce, Bureau of Standards, and other

interested agencies it expects to assume the leadership in directing the location and activities of the broadcasting stations in the United States. In order to take care properly of the interests of the various districts into which it has seemed advisable to divide the radio field, local radio chambers are to be formed which will function under the parent body having headquarters in New York. Chicago was selected as the place to start the first local chamber.

There is a great deal of useful work which can be done in the field of properly caring for the activities of the various broadcasting stations as was evidenced on two recent occasions of importance. There was the Friars' dinner on the programme of WJZ and many listeners, thousands of them far from New York, justifiably anticipated an evening's real enjoyment; the speakers were some of the best in America. The affair was late in getting started, as such affairs are likely to be. Much time was spent in broadcasting the menu and table manners of the worthy friars, but finally the anticipated humor and skill of the spokesmen was on the ether. Scarcely had the fun begun, however, when the announcer had to bid us good-night, as his allotted time was up; WJZ must shut down as the next hour had been assigned for broadcasting purposes to a small station in the vicinity of New York, and of course WJZ had to abide by the agreement. A very large radio audience was sadly disappointed as was evidenced by comments on all the commuters' trains next morning, and by notices in the local press. Shortly after this occurrence, the convention of the American Society of Mechanical Engineers, participated in by economists of America, was interrupted in the same fashion. On both these occasions the interests of the radio public were badly served—WJZ should have been able to continue its programme as the importance of the material being broadcast justified encroachment on the period assigned to the small stations which were sending

out comparatively weak programmes—weak artistically as well as electrically.

It seems to us that on such an occasion the local authorities should be able at once to make arrangements to permit the continuance of the more important broadcasting programme. In fact, the need of such a flexible arrangement is evident to any person interested in the increased utility of the broadcasting service. At the beginning of the period assigned to the smaller station the local radio authority should be able to, and should, announce that the smaller station had been temporarily assigned to broadcast on—meters instead of the customary—meters, so that Station—could continue its programme. The wave difference between the two stations should be chosen large

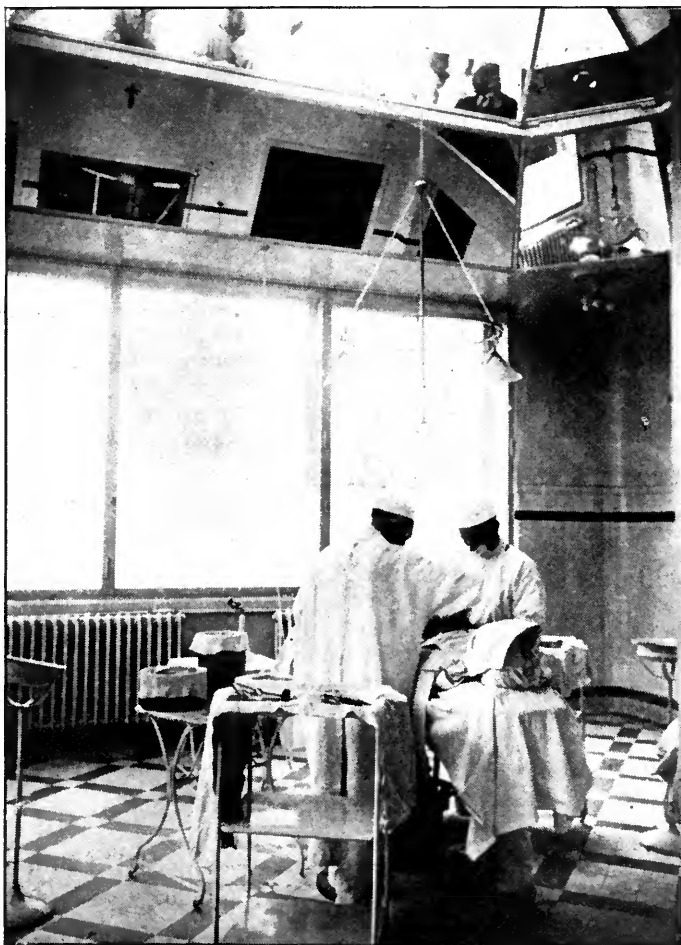

AN OPERATION IS IN PROGRESS

While doctors and students observe the work carefully, from above. All sounds are carried to them through the microphone, which stands on a table below the middle window. In this way forty or fifty people can study the operations without disturbing the surgeons

enough so that those desiring to listen to the poorer programme could do so without interference from the more powerful station. This new plan would result in some dissatisfaction at the smaller station, but it would be much less than under the present plan.

Was there ever such an absurd situation? Plenty of wavelengths available—a governmental radio service intelligent and capable enough to put any plan of this kind into effect—and yet nothing done. Let us see what the National Radio Chamber of Commerce can do in the matter. They surely have our well wishes in anything they undertake along the line of starting the governmental machinery into motion.

Simpler Instructions, and Service, for Ready-Made Sets

THE following letter, making a plea for simpler instructions and a service of some kind for bought apparatus, came to the Editor's desk a few days ago:

EDITOR "RADIO BROADCAST,"
Garden City, N. Y.

DEAR SIR:

Can't you use your influence to induce the makers of radio instruments to give service which will make their instruments more useful and valuable?

I have now purchased at one time or another four different instruments, and with none of them was I able to get competent instructions, or even printed matter which was intelligible to a person unfamiliar with radio technicalities.

It may be all right to assume that because a man buys a radio instrument he is one of these super boy amateurs, or a college professor; but, as a matter of fact, a very large number of people who *would* buy instruments need to have careful instructions, and there should be people who can teach them how to run the machines to get the most out of them. I should think one of the most dangerous points that the industry has to face is the selling of instruments which do not give satisfaction for one reason or another.

All of which is respectfully submitted.

Very truly yours,

A RADIO FAN.

It cannot be doubted that the opinion of thousands of set-owners, who do not know where to turn for help in operating the receiving sets which they have purchased, is voiced by the writer of this letter. As one of our readers expressed it recently: "We get thirteen pages of directions with a liver pill and practically

nothing with most radio receivers." Nothing, that is, that the newcomer in radio can understand and use in operating his set to the best advantage. What is very evidently needed is simple instructions in "plain American." The radio set owners of to-day include more newcomers in the broadcasting game than old-timers, and they cannot be expected to rush in, successfully, where all but old-timers fear to tread.

Rather complicated receiving sets are frequently accompanied by nothing but wrapping paper and excelsior. In some cases, where manufacturers do supply instructions, they miss the mark entirely, because the old-timer will "arrive" by experiment, anyway—in fact, he derives his greatest pleasure from trying various methods of bringing in better and stronger signals—and the novice will put aside the circular after five minutes, when he finds that it is (from his point of view—*which is the only point of view that counts!*) quite incomprehensible.

What happens when a novice buys a set, gets it home, and starts to put it in operation? First of all, most of the electrical names so commonly tossed about by the fraternity—or even by the fourteen-year-old boy experimenter—mean nothing to him. And why should they? He is not necessarily "good at electrical things"; he is probably interested in learning, in time, some of the theory of radio transmission and reception, but to begin with, he wants results—signals—music. And he doesn't want to have to appeal (as frequently seems necessary to him) to an electrical engineer or a college professor to get them.

There is a crying need also for adequate instructions for getting the *best* results—not merely results. As it is, many a fine receiving set lies idle, or limps along on two cylinders.

Granted all this, how are instruction sheets or pamphlets to be prepared that are of real value to the "consumer"? One way is for the manufacturer to put himself in the place of the non-technical buyer, and supply in black and white the information that he would be likely to need. Another way is for the manufacturer to get hold of some acquaintance—an out-and-out neophyte, whose knowledge of radio is nil—make him thoroughly familiar with the care and operation of a given set, and then have *him* write the directions for others.

The first method of attacking the problem is likely to be difficult for the man who exists in an atmosphere of technical terms. To him,

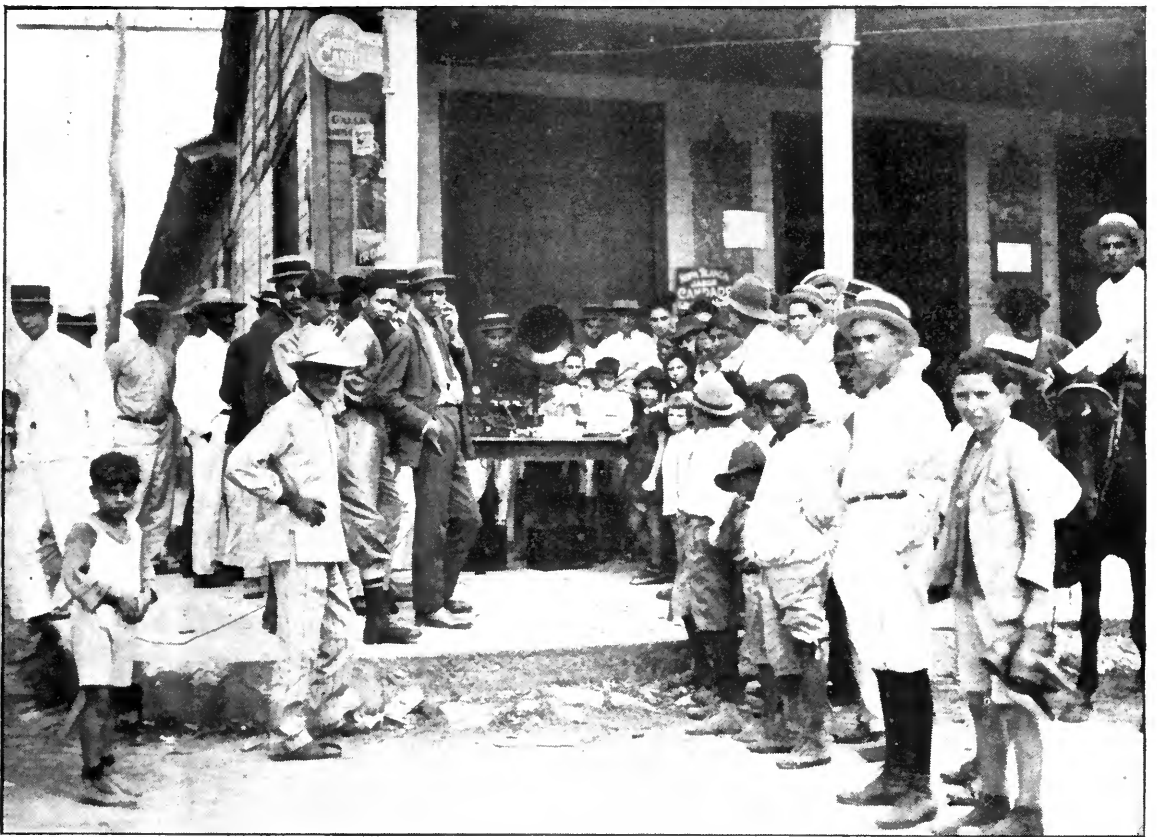

© Underwood & Underwood

LISTENING TO CUBA — FROM CUBA

A Sunday crowd gathered about the grocery and liquor store at San Jose de las Lajas, a "four corners" 25 miles from Havana, to see their first radio set and hear their first concert broadcasted by station PWX of the Cuban Telephone Company

everything about the operation of the set he manufactures may seem childishly simple. But the second method—having one of those people for whom the greater number of sets is destined, do the explaining—ought to work out satisfactorily, if the results are carefully checked up by the technical man. In fact, the best way of all might be for representatives of both maker and buyer to write instructions separately, and then get together and boil down and clarify the results in non-technical language, including all that is necessary for any buyer to know. A few symptoms of, and remedies for receiver ills, might also well be included.

Facilities for supplying service to owners of receiving apparatus should be a logical development of the business of producing and selling broadcasting receiving sets. Until this service is developed, however, manufacturers should provide, and buyers should demand, simple and adequate instructions for the care and operation of their apparatus.

Ocean Letters by Radio

ACCORDING to a recent announcement from the Shipping Board, a radio letter service has been inaugurated on its vessels for the convenience of its travelers. Messages from a ship bound in one direction are to be transmitted by radio to a ship bound in another direction for mailing when the receiving ship arrives at her destination. Thus a passenger on a ship from New York for Liverpool might, when two days out, want to send a letter back to New York; his letter is sent by radio to the nearest Shipping Board vessel steaming to New York, and it will be put in the mails when this vessel reaches port.

Including registration fee, the rate for this service will be \$1.20 for a letter of twenty words; each additional word will be charged at the rate of four cents a word. Letters are limited in length, 100 words being the maximum allowed for one letter.

J. H. M.

“Out-of-the Studio” Broadcasting

By WILLIAM H. EASTON, Ph. D.

Westinghouse Electric & Manufacturing Co.

THE outstanding feature of broadcasting during the present season is the large number of “out-of-the-studio” events that are being broadcasted by some of the larger stations through wire connections direct from the scene of action. Prominent among the events that have thus been given to the radio audience are the World Series baseball games and championship football contests; boxing matches; organ recitals, symphony concerts and grand opera, plays, banquets and civic exercises; addresses by famous men, church services; and even a message of the President to Congress. To say that the radio audience appreciates programmes of this sort is to put it mildly—even the dyed-in-the-wool “DX amateur” admits that now there *is* something in broadcasting.

Broadcasting is, in fact, entering into the third stage of its development. In the first stage, the phonograph is the main reliance.

Practically all broadcasting stations started at this point, and many have never gotten beyond it. Phonographic programmes are simple and inexpensive. No special equipment is required except the actual transmitter, and no staff except the operators. A friendly music dealer, who hands out a dozen or so records every day in return for the mention of his name and address in the ether, provides the bulk of the entertainment.

In the second stage of development, artists in person form the chief attraction. This is a greater step in advance than most listeners realize. First of all, there must be a place for the artists to perform in. The ordinary transmitting room is utterly unsuitable for such purposes, so that a studio must be provided. This studio should be well furnished; it must contain a piano and other musical instruments; and it ought to be made sound-proof and free from echoes. There must also be a competent



CLEAR TRANSMISSION OF GROUP SINGING IS DIFFICULT
But thanks to acoustical and electrical experts, thousands have enjoyed the singing of this choir, of St. Thomas's Church, New York



THE ANNOUNCER AT A CHURCH SERVICE HAS AN INCONSPICUOUS POSITION

The cabinet beside him controls the system of microphones, which are located at various points in the church, and also the degree of amplification used for each selection. He is in communication with the broadcasting station by telephone, and he listens-in to the service as it is broadcasted by means of a local receiving set

staff to engage and receive the several thousand artists utilized every year by a station in daily operation; and finally, there should be a musical director to select voices and arrange well balanced programmes. All this involves a good-sized organization and considerable expense.

It was the studio that transformed broadcasting from a curiosity into a national institution of culture. By providing the proper accommodations, it made possible the transmission of solos and speeches of every description, concerts by full bands, orchestras, and choruses, and even oratorios and condensed operas. But its resources are not inexhaustible. After a programme manager has staged three or four different events every night for a year or so, he finds that he is milling around in a circle. His programmes have become monotonous even in their extreme variety, and real novelties are almost unobtainable.

Then, those stations in a position to do so, take the third step and go out of the studio for their chief features. An immense field is thus opened up, especially for stations located in large cities, since experiments show that practically anything that is audible can be broadcasted in this manner.

The use of wires to reach outside events originated with KDKA, the Westinghouse station at East Pittsburgh. As early as January, 1921, this station broadcasted services direct from Calvary Church, Pittsburgh, and in the same month, it sent out a speech by Secretary Hoover from the Duquesne Club of that city. A few weeks later, it transmitted a boxing contest direct from Duquesne Gardens, and the radio audience heard for the first time the shouts and applause of the spectators at an athletic event. In the following year, KYW, Chicago, made notable use of wire connections by broadcasting almost every performance of the Chicago Opera Company.

This year, about a dozen other stations are undertaking this highest grade of service. The list will probably never be a long one because highly special apparatus and expert operators are needed for this work. In addition, the cost of installing and renting the necessary wires is high.

It is no easy matter to broadcast "out-of-the-studio" events successfully. In the studio, everything is under the control of the manager and all speakers and artists can be arranged with reference to the microphone. Outside,

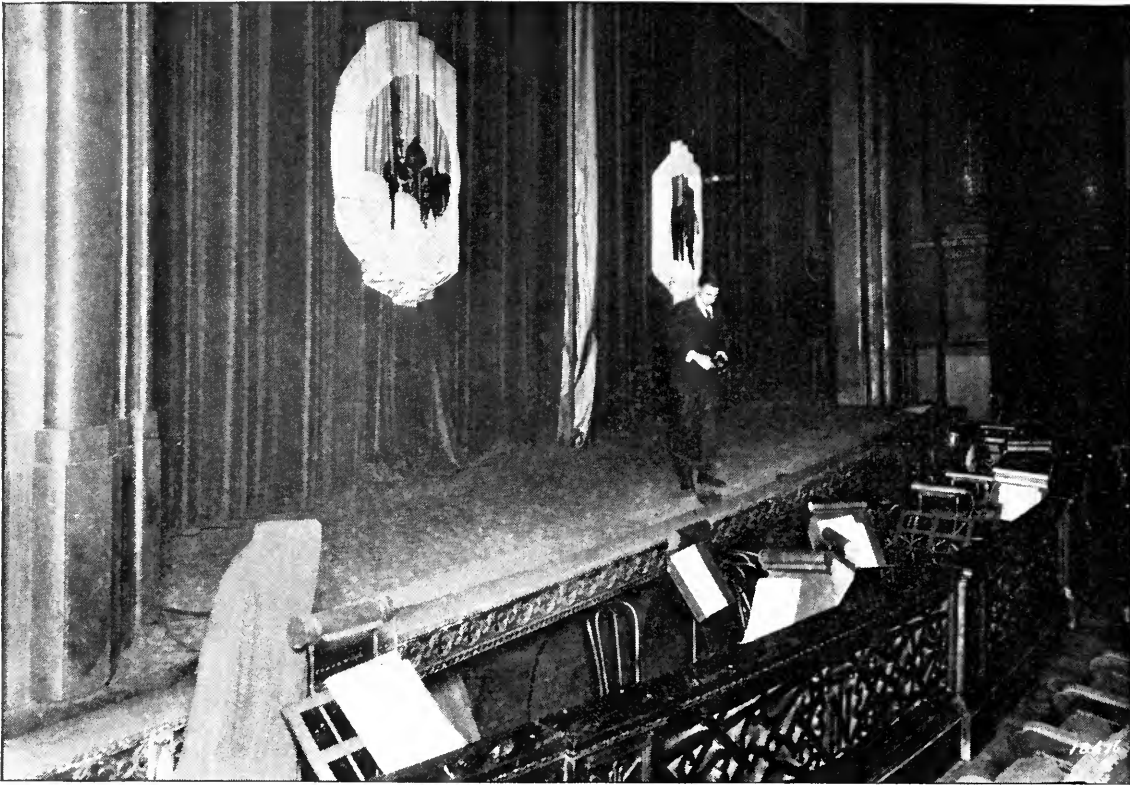

EXPLORING THE ACOUSTIC PROPERTIES OF A THEATRE
Prior to installing the equipment which is to carry the sound to the broadcasting station

however, the broadcaster has no control, and he must arrange his transmitting apparatus to suit the messages to be transmitted. This means a very careful study of each "location." What are the acoustic properties of the scene of action? Will there be speakers? If so, how many? Where will they be? What sort of voices will they have? Is there much extraneous noise? If so, is it to be broadcasted (as with applause) or eliminated? Are there any special noises that are particularly wanted (as with the gong at a prize fight)? What sort of music will there be? Is it to be orchestral, organ, piano, or choral? Will there be solos? Is there to be great variation in the volume of music?

All of these questions, and many more, must be correctly answered, and arrangements to cover every possible contingency must be made in advance, for there is little opportunity to make changes during the broadcasting, and every detail of the event must be transmitted perfectly or else the radio audience will protest most vigorously.

The most complicated event to broadcast is

an Episcopal Church service, owing to the number of places from which the minister speaks, and the great variations in the volume and character of the music. A brief description of the method used by the Westinghouse-Radio Corporation Station WJZ to broadcast the services of St. Thomas's Church, 5th Avenue and 53rd Street, New York, will serve to illustrate how problems of this sort are solved.

Nine microphones are used in this installation, located as follows: in the anteroom where the opening and closing prayers are said; on the pulpit for the sermon; on the lectern for the service prayers; on the reading desk for the lessons; on the altar rail for the creed and other parts of the service; on the altar for the communion prayers; near the organ for the organ voluntaries; in the chandelier for the choir; and in a place that is out of the way but still commands a view of the service for the radio announcer and operator. All of these microphones are connected to a little switchboard controlled by the radio operator. He also has a small cabinet providing three stages of amplification, connected with the wire line

to the station and supplied with energy from a storage battery. A receiving set, which tells him what is going on in the ether, and a telephone line to the station, complete his equipment.

During the service, the operator is a busy man. He must not only switch on the proper microphone to transmit whatever is happening at the moment, but he must constantly change the degree of amplification to correspond with changes in the volume of the sound. To do this without producing abrupt crashes of sound in the listeners' receiver, or the even more disturbing breaks in the continuity of the service, requires a great deal of skill and quick judgment.

Other installations provide other problems. When arrangements were being made to broadcast Clemenceau's speech at the Hotel Pennsylvania, for example, it was found that the "Tiger" always walked around when he spoke, so that no single microphone could catch all he said. Investigation showed, however, that the speaker would be confined to a narrow aisle formed between the long table at which he was to sit, and the wall. A string of a dozen micro-

phones, concealed in the decorations, was placed on this table; and as Clemenceau paced up and down, the operator followed his movements by switching on one microphone after another.

At football games, there is generally a microphone for the announcer, placed high up in the stands where a good view can be obtained, and two in the field, each opposite a students' section, for the cheers and songs. Some difficulty was experienced in making the announcer heard over the uproar, especially during critical plays, and the latest practice is to place him in a sound-proof booth.

Theatrical plays are especially difficult to broadcast because the actors move over so large an area and have voices of such different qualities. Furthermore, the microphones can be located only in the footlights, wings, and prosceniums, and not directly on the stage where they should be. These difficulties are even greater in the case of grand opera, where the stage is apt to be much larger and the variation in tone much wider.

The chief value of "out-of-the-studio" broad-



THE SPEAKERS' TABLE AT THE FRIARS' CLUB BANQUET

Held recently at the Hotel Astor, New York. People as far west as Minnesota and Kansas attended the banquet by radio. Four microphones may be seen in the picture, placed at intervals on the long table. Among the speakers were George Cohan, DeWolf Hopper, Judge Kenesaw Landis, and Will Rogers



BROADCASTING DANCE MUSIC FROM A PLACE WHERE THERE IS DANCING

Vincent Lopez' well-known orchestra, in the Hotel Pennsylvania grill room, is heard twice a week by WJZ's audience

casting lies in the possibility of securing events that cannot be staged in the studio. But there is also another factor that is important; namely, the atmosphere of life that is transmitted. The artist or speaker in the studio is addressing a silent audience. When he indulges in humor, there is no laughter; when he scores a point, there is no sign of approval; and when he finishes, there is no applause. But when the affair is broadcasted in the presence of a real audience, both the speaker or artist and the radio audience feel the difference.

The great difficulty with outside broadcasting is the poor acoustic conditions that are often encountered. Proper location of the microphone will sometimes remedy the worst defects, but there is usually a great deal of echoing and extraneous noises. The best artistic results will therefore always be obtained in the well-designed studio, until (which is more than likely to happen) theatres, churches, auditoriums, and other public places are specifically designed with reference to broadcasting.

Another difficulty is that, owing to the time schedules on which most stations operate, it is often necessary to close down in the middle of an interesting outside event. This always vastly irritates the radio audience, but it is never the fault of the stations doing the broad-

casting. They always endeavor to obtain extension of time from the stations scheduled to follow them, but if this is refused, they have no option but to cut off. The remedy is obviously to give a free hand to those stations who are earnestly engaged in improving the quality of broadcasting.

This development of broadcasting still further emphasizes the difference between the better and the poorer stations. The Chicago Grand Opera, as broadcasted from KYW twice a week, could be heard over nine-tenths of the United States on a single stage of amplification, provided there was no local interference. As it is, probably only a small proportion of the radio audience can hear much of this really great undertaking, except a few snatches now and then between the lulls of local jazz and other trivialities. Stations that are doing creative, worth-while work earn their places in the ether; but too many stations are unable to do more than weakly imitate the poorest efforts of the leaders and do actual injury to broadcasting by interference and by occupying time that could be applied to better advantage. The radio audience, in fact, does not know what it is losing—how many first class events are not scheduled by the larger stations, simply because their time schedules do not permit them to do all they would like to do.

How Our Lighthouses Use Radio

By GEORGE R. PUTNAM

U. S. Commissioner of Lighthouses

IT IS only 26 years since wireless telegraphy was proven a practicable possibility, but in this brief period its use has developed to be of the greatest value in safeguarding navigation, in increasing the efficiency of the operation of ships, and in adding to the comfort and convenience of those travelling upon the sea. The U. S. Lighthouse Service has the definite function of providing marks or signals for the guidance of vessels, and in carrying out this important responsibility, wide use has been made of radio in furnishing additional safeguards for shipping, in facilitating the operation of the Service itself, and in providing instruction and relaxation for its personnel.

The most important use of radio in Lighthouse Service work is its use to protect ships in fog, through the establishment of fog signals, which, in conjunction with the radio compass on shipboard, give the navigator for the first time a means of taking accurate bearings on invisible objects. Electric waves readily penetrate fog, and can be received at much greater distances than light and sound waves, on which the mariner has heretofore had to depend.

Fog and other conditions rendering objects invisible constitute the greatest menace to safety of shipping, and demand every help that science can give to vessels thus imperiled. The development of fog signals has lagged much behind the improvement of lighted aids. The first fog signals in this country were guns, fired occasionally, and it was a hundred years after the building of the first lighthouse at Boston before a fog bell was installed on our coast, and not until about 60 years ago were the first air and steam signals used. The fog conditions differ greatly in different regions. The North Atlantic coast of

the United States and portions of the Pacific and Alaska coasts are extremely foggy, while on the South Atlantic and Gulf coasts and in Porto Rico and Hawaii there is little fog. The highest record of fog for a year is 2,734 hours, or 31% of the total time, at Seguin Light Station, Maine. There is a record of $7\frac{1}{2}$ days of continuous fog at a station, requiring the operation of a fog signal 181 hours without cessation.

The Lighthouse Service on May 1, 1921, placed in commission the first radio fog signals in this country, at 3 stations in the vicinity of New York Harbor: on Ambrose Channel and Fire Island Light Vessels, and at Sea Girt Lighthouse. Since that time additional radio fog signals have been established on the light vessels at the entrance to San Francisco and on Diamond Shoals Lighthouse off Cape Hatteras. Provision is being made for seven additional stations, on Boston, Nantucket Shoals and Cape Charles Light Vessels, and at Cape Henry Lighthouse on the Atlantic coast, and on the light vessels anchored off the entrance to the Straits of Fuca (Swiftsure Bank), off the Columbia River, and off Cape

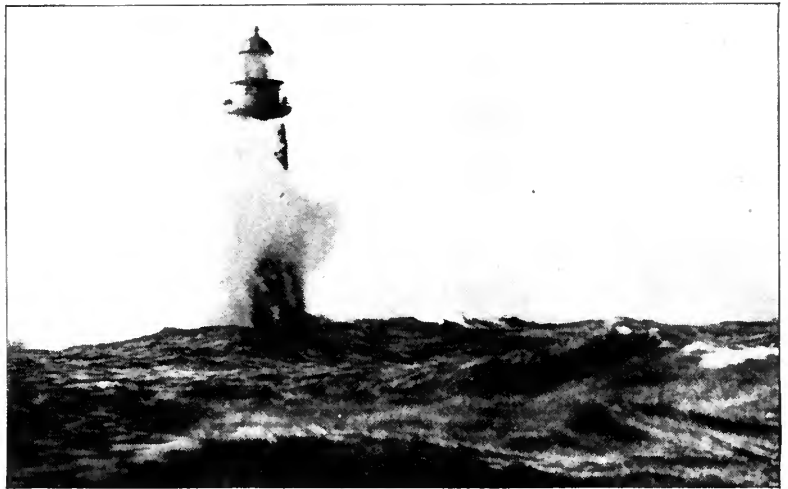

NONE BUT THE HARDIEST

Of the brine-beaten sons of Neptune could sleep through a buffeting like this. A week of this life would wreck the nerves of the average land-lubber. This lighthouse, located on Minot's Ledge off the coast of Massachusetts, now has a telephone connection through a cable, but a radio receiving set would greatly lessen the isolation of the keepers

Mendocino (Blunts Reef). The relief light vessels, which replace the station ships, are also being supplied with apparatus.

This system is based on the installing in selected important lighthouses and light vessels along the coast of apparatus for sending automatically, during the continuation of fog or thick weather, radio signals of simple characteristics by means of which the navigator of any vessel provided with a radio compass may take definite bearings to guide or to locate his ship, although no object is visible.

The locations of radio fog signal stations in this country have been selected so as to furnish convenient leading marks for vessels approaching the principal harbor entrances which are subject to much fog. The group of stations near New York provides a means of location also by cross bearings. Each station has a distinctive signal. Thus, Ambrose Channel

sends one dash, Fire Island a group of two dashes, and Sea Girt a group of three dashes, with brief intervals between the groups. The particular station on which a radio bearing is being taken in a fog is by this means just as definitely known as is the light on which a sight bearing is taken by the navigator of a ship, identified by its order of flashes or color. The signals are operated continuously during thick or foggy weather, and also at the present time they are sent each day from 9 to 9:30 a. m., and from 3 to 3:30 p. m., so as to permit any vessel equipped with radio compass to try out the method and apparatus in clear weather. To avoid continuous interference between the signals themselves for stations in one vicinity, they are sent on different time schedules as follows: Ambrose sends for 20 seconds, silent 20 seconds; Fire Island sends for 25 seconds, silent 25 seconds; Sea Girt sends for 60 seconds,

silent 6 minutes. The signals are repeated rapidly, Sea Girt, for example, sending over 40 groups of dashes a minute.

The transmitting apparatus now in use is a commercial panel type transmitting set of simple and rugged construction of about 1-kilowatt power. In addition to this set, a special automatic motor-driven timing switch for producing the desired signal at regular intervals is provided. The antennas at the transmitting stations are the same as used for ordinary radio communication. The wavelength used is 1,000 meters, the present international standard for such signals, and the range of usefulness varies from 30 to 100 miles, depending upon the sensitiveness of the receiving apparatus.

The radio fog signal stations are operated by the regular personnel of the light stations and vessels, and the radio compasses on shipboard may be used directly by the navigating officers of the vessels or by the wireless operators, so that at neither end are additional persons or specially trained technical men required. Of course radio experts are necessary for installing the equipment, calibrating the compasses, and making the periodic inspections.

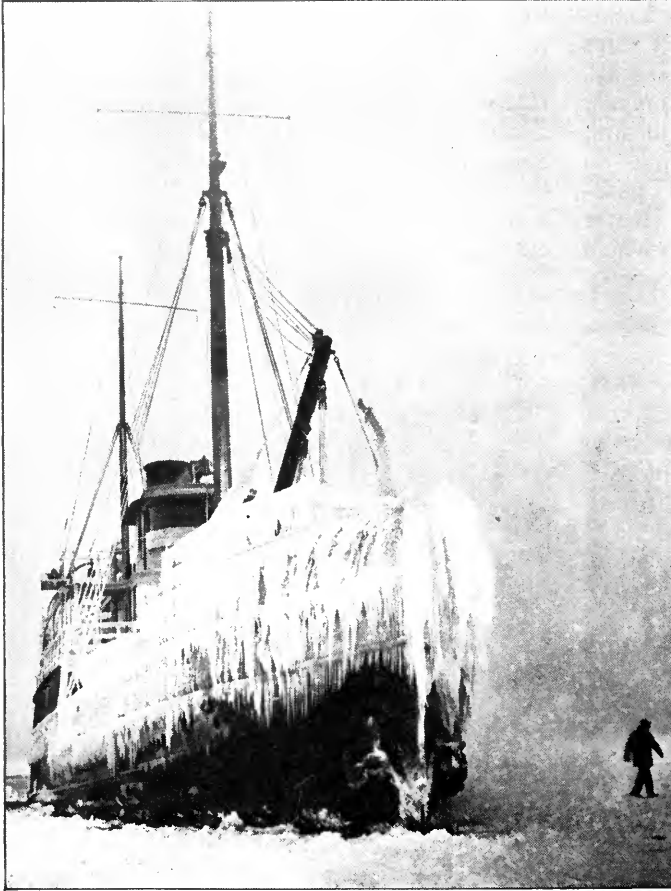

U. S. LIGHTHOUSE TENDER "MARIGOLD"
Completely hemmed in. In places like this it is good to be able to keep in touch with the rest of the world

The important possibilities of utilizing the directive element of radio signals for the location of vessels in fog were recognized ten or more years ago, but the successful application of the idea in this country was greatly advanced by the development by the Bureau of Standards of a simple and effective radio compass suitable for use on shipboard. Extensive tests have been carried out by the Lighthouse Service and the Bureau of Standards commencing in January, 1917, of radio signal sending apparatus and radio compasses mounted on lighthouse tenders.

The value of radio fog signals has been recognized internationally by the action in 1920 of the Preliminary Conference of the Universal Electrical Communications Union in setting aside the wavelength of 1000 meters for radio beacons.

During the World War considerable use was made abroad of radio compass stations located on shore for obtaining bearings of ships and furnishing this information for use in navigation, especially of naval vessels. After the war the Navy Department established such stations on the coast of the United States, to be operated in conjunction with the naval communication stations already existing. A number of these shore compass stations are now in active operation on both the Atlantic and Pacific coasts, and are furnishing many bearings to ships asking for them. These stations are usually arranged in groups. The system is the reverse of that employed by the Lighthouse Service, in which the navigator determines the position of the ship himself.

While the use of the radio compass on shipboard is only in an early stage of development, the results already obtained give strong indication that it will prove an addition of the highest value to the navigational equipment of a ship. Bearings on automatic radio fog signals may be taken directly by the navigator, without knowledge of radiotelegraphy, but for taking bearings on other sending stations and on vessels it is necessary to be able



MORE DECORATIVE THAN HELPFUL

That is the light-tender's opinion of these cold-weather caprices that Nature has engaged in at the expense of the Ludington North Breakwater Light

to recognize the calls. The radio compass gives the navigator an instrument by which he may obtain bearings on invisible signals at will, and these may be repeated and checked as often as needed. The radio compass on shipboard will probably prove to be an instrument of very wide possibilities in navigation, for in addition to taking bearings on especially established radio fog signal stations, it may be used throughout the world for bearings on radio sending stations whose location is known; for bearings of vessels approaching or meeting, so as to avoid collision in fog; for bearings of vessels in distress; and for mutual bearings between a vessel and its boats in a fog, as for example, fishing boats and the mother ship. It should be possible to equip life boats so that their position may be detected by means of radio, and this may be the means of saving many lives.

Radio communication has greatly added to the safety of life at sea by enabling a vessel equipped with radio to call for help when needed. A recent striking case of this was the burning of the steamer *City of Honolulu* in the Pacific Ocean 700 miles from land, on October 12, 1922, when the entire ship's company of 260 persons had to put to sea in small boats. The nearest vessel at the time was many miles away, but the SOS call brought assistance promptly and there was no loss of life. Without radio communication, such a dis-

Mendocino (Blunts Reef). The relief light vessels, which replace the station ships, are also being supplied with apparatus.

This system is based on the installing in selected important lighthouses and light vessels along the coast of apparatus for sending automatically, during the continuation of fog or thick weather, radio signals of simple characteristics by means of which the navigator of any vessel provided with a radio compass may take definite bearings to guide or to locate his ship, although no object is visible.

The locations of radio fog signal stations in this country have been selected so as to furnish convenient leading marks for vessels approaching the principal harbor entrances which are subject to much fog. The group of stations near New York provides a means of location also by cross bearings. Each station has a distinctive signal. Thus, Ambrose Channel

sends one dash, Fire Island a group of two dashes, and Sea Girt a group of three dashes, with brief intervals between the groups. The particular station on which a radio bearing is being taken in a fog is by this means just as definitely known as is the light on which a sight bearing is taken by the navigator of a ship, identified by its order of flashes or color. The signals are operated continuously during thick or foggy weather, and also at the present time they are sent each day from 9 to 9:30 a.m., and from 3 to 3:30 p. m., so as to permit any vessel equipped with radio compass to try out the method and apparatus in clear weather. To avoid continuous interference between the signals themselves for stations in one vicinity, they are sent on different time schedules as follows: Ambrose sends for 20 seconds, silent 20 seconds; Fire Island sends for 25 seconds, silent 25 seconds; Sea Girt sends for 60 seconds, silent 6 minutes. The signals are repeated rapidly, Sea Girt, for example, sending over 40 groups of dashes a minute.

The transmitting apparatus now in use is a commercial panel type transmitting set of simple and rugged construction of about 1-kilowatt power. In addition to this set, a special automatic motor-driven timing switch for producing the desired signal at regular intervals is provided. The antennas at the transmitting stations are the same as used for ordinary radio communication. The wavelength used is 1,000 meters, the present international standard for such signals, and the range of usefulness varies from 30 to 100 miles, depending upon the sensitiveness of the receiving apparatus.

The radio fog signal stations are operated by the regular personnel of the light stations and vessels, and the radio compasses on shipboard may be used directly by the navigating officers of the vessels or by the wireless operators, so that at neither end are additional persons or specially trained technical men required. Of course radio experts are necessary for installing the equipment, calibrating the compasses, and making the periodic inspections.

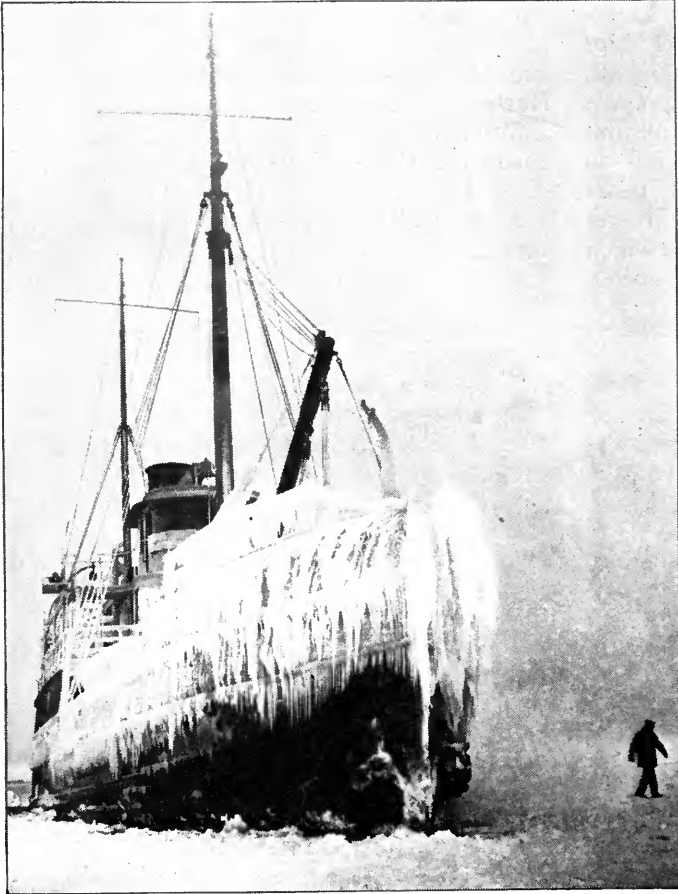

U. S. LIGHTHOUSE TENDER "MARIGOLD"
Completely hemmed in. In places like this it is good to be able to keep in touch with the rest of the world

The important possibilities of utilizing the directive element of radio signals for the location of vessels in fog were recognized ten or more years ago, but the successful application of the idea in this country was greatly advanced by the development by the Bureau of Standards of a simple and effective radio compass suitable for use on shipboard. Extensive tests have been carried out by the Lighthouse Service and the Bureau of Standards commencing in January, 1917, of radio signal sending apparatus and radio compasses mounted on lighthouse tenders.

The value of radio fog signals has been recognized internationally by the action in 1920 of the Preliminary Conference of the Universal Electrical Communications Union in setting aside the wavelength of 1000 meters for radio beacons.

During the World War considerable use was made abroad of radio compass stations located on shore for obtaining bearings of ships and furnishing this information for use in navigation, especially of naval vessels. After the war the Navy Department established such stations on the coast of the United States, to be operated in conjunction with the naval communication stations already existing. A number of these shore compass stations are now in active operation on both the Atlantic and Pacific coasts, and are furnishing many bearings to ships asking for them. These stations are usually arranged in groups. The system is the reverse of that employed by the Lighthouse Service, in which the navigator determines the position of the ship himself.

While the use of the radio compass on shipboard is only in an early stage of development, the results already obtained give strong indication that it will prove an addition of the highest value to the navigational equipment of a ship. Bearings on automatic radio fog signals may be taken directly by the navigator, without knowledge of radiotelegraphy, but for taking bearings on other sending stations and on vessels it is necessary to be able



MORE DECORATIVE THAN HELPFUL

That is the light-tender's opinion of these cold-weather caprices that Nature has engaged in at the expense of the Ludington North Breakwater Light

to recognize the calls. The radio compass gives the navigator an instrument by which he may obtain bearings on invisible signals at will, and these may be repeated and checked as often as needed. The radio compass on shipboard will probably prove to be an instrument of very wide possibilities in navigation, for in addition to taking bearings on especially established radio fog signal stations, it may be used throughout the world for bearings on radio sending stations whose location is known; for bearings of vessels approaching or meeting, so as to avoid collision in fog; for bearings of vessels in distress; and for mutual bearings between a vessel and its boats in a fog, as for example, fishing boats and the mother ship. It should be possible to equip life boats so that their position may be detected by means of radio, and this may be the means of saving many lives.

Radio communication has greatly added to the safety of life at sea by enabling a vessel equipped with radio to call for help when needed. A recent striking case of this was the burning of the steamer *City of Honolulu* in the Pacific Ocean 700 miles from land, on October 12, 1922, when the entire ship's company of 260 persons had to put to sea in small boats. The nearest vessel at the time was many miles away, but the SOS call brought assistance promptly and there was no loss of life. Without radio communication, such a dis-

aster might have had an appalling result. Only a few days ago, in Alaska, by reason of radio communication, it was possible to get the light-house tender *Cedar* to the aid of the passenger steamer *Jefferson* within four hours of the time the latter vessel lost her propeller; the *Jefferson* was drifting helplessly in the dangerous waters of Dixon Entrance and the *Cedar* with some difficulty took the vessel in tow and brought her into port. But there are cases where the call for help alone is not sufficient to bring sure relief; the vessel in distress may be enveloped in fog or may be much out in its reckoning, making it difficult to find, and the resulting delay may mean the difference between saving and losing lives. The radio compass has already proven of the greatest value in the location of vessels in distress.

The following are illustrations of the importance of radio bearings in rescue work, which have recently been reported:

During somewhat heavy storms in the North Atlantic, the Norwegian steamer *Mod* was so badly damaged that she became practically a wreck, and for thirty-six hours the crew were huddled on deck without food. The captain sent out an SOS message, giving what he believed to be his position, but which proved erroneous. At least six vessels diverted their courses in an endeavor to render help, but no trace of the *Mod* could be found. For some time the British vessel *Melmore Head* was too far away to be of any assistance, but the captain kept in touch with what was happening, and when he found the *Mod's* signals getting stronger he directed the wireless operator to ascertain her position by means of his direction finding apparatus. According to the reading thus obtained the *Mod* was seventy-eight miles away from the position she herself had sent out and in an entirely different direction. The Captain of the *Melmore Head* placed his reliance on the direction finder and found it to be correct, arriving at the foundering vessel just in time

to save twenty-three members of the crew before the *Mod* sank.

The rescue of the crew of the Norwegian steamer *Ontaneda* constitutes a triumph for one of the latest developments of wireless science. A heavy gale had left the *Ontaneda* drifting helplessly with broken down engines and listing at an angle of 50 degrees in a heavy sea. Her captain sent out the SOS signal, but in the thick weather he could get no observations of sun or stars, and had to estimate his

position by dead reckoning. His calculations proved to be ninety miles out. Several vessels went to his assistance and steamed about near the position given without finding a trace of the *Ontaneda*, but the steamer *Fanad Head*, by means of her direction finding apparatus, discovered the true position of the vessel. She was nearer to the *Fanad Head* than to the ships which had originally steamed to her assistance, and the captain of the *Fanad*

Head proceeded to the spot where he calculated the *Ontaneda* to be. The wireless direction proved to be correct, and the distressed sailors were rescued.

On the night of March 15, 1922, the British steamer *Lord Strathcona* lost her propeller in a rough sea and sent out signals of distress. The American steamer *W. M. Burton* was assigned to her assistance, but upon arriving at her given position no signs of the vessel could be seen. The captain on the disabled ship was uncertain of his position. The visibility was very poor at the time and nothing could be seen further than one mile. The British ship *Cassandro*, which had a radio compass in its radio equipment, gave the bearings of the two ships from her position and very shortly afterward the steamer *Lord Strathcona* was sighted.

In August, 1921, the steamer *Wabkeena* was within 14 miles of the steamer *Alaska*, off Cape Mendocino, Calif., when she picked up the radio distress signals of the *Alaska*, but it

Making Life Safe at Sea

Radio is being used in many ways undreamed of a year or two ago, but its one greatest purpose remains, and will remain, the safeguarding of our marine carriers and their human cargoes.

But the number of those who lose their lives at sea is still appallingly great. The pity of it is that some of this loss could be avoided by better equipment in our merchant marine. It is significant that most of the vessels referred to by the author of this article as not knowing their own location, were found by radio compass on *foreign vessels* answering the S O S.

America leads in several branches of radio, but not in its marine applications.—THE EDITOR.

was 10 hours before the *Wabkeena* reached the scene of the wreck, having no means of determining the direction of the signals; of the 42 lives lost in the disaster, many might have been saved had there been a radio compass on the *Alaska*, and on the *Wabkeena*. The radio operator of the *Alaska* wrote: "Strongest in my mind remains the picture of the *Wabkeena* 12 or 15 miles from us at 9:15 p. m., and after that, trying unsuccessfully all night to locate us, while many unfortunate human lives were clinging to floating wreckage and succumbing slowly to exposure."

RADIO COMMUNICATION WITH LIGHT VESSELS

THE Lighthouse Service maintains light vessels on 49 stations. Of these, 22 are on exposed positions in the open sea; these are the outermost signal stations of the country; they are of the greatest value to navigation, and they are also the most difficult aids to maintain. They are placed off the principal harbor approaches, and offlying dangers along the Atlantic, Gulf and Pacific coasts, and these small vessels and their crews are exposed not only to the danger of storms, anchored in the open ocean, but to the risk of collision, as most of the vessels lay their courses for these lightships and endeavor to pass close to them regardless of fog or weather. Nantucket light vessel, a mark for most of the transatlantic vessels, is 41 miles from the nearest land, and there are always many vessels headed for this spot.

There are evident advantages in maintaining radio communication stations on the more isolated of these vessels, as this permits the vessel to report promptly an accident occurring to it, or a defect in the signal lights or fog signal apparatus, or need of supplies or medical assistance, or a disaster to other craft in the



BRINGING THE SUPPLIES AND NEWS

Landing in bad weather is not so easy as this, and it is sometimes necessary to employ a crate, swung out over the boat on a long boom. This is Bishop and Clerks Light Station, Massachusetts

vicinity and the need of relief, and to forward reports of passing vessels, transmit messages from vessels not equipped with radio or whose radio is out of order, and to forward special information. The radio furnishes ready communication between the district office and the light vessel, and enables orders to be sent to the vessel, and reports and requisitions from the vessel.

One of the earliest service installations of the Marconi system of wireless telegraphy was in 1898 between the East Goodwin lightship and the South Foreland lighthouse in England; this communication was maintained for over a year, and was the means of saving both life and property. Radio was installed experimentally on Nantucket Shoals light vessel in 1901, its first use in lighthouse work in this

country. At the present time radio communication is maintained by the Lighthouse Service on 20 light vessels. Most of the apparatus was originally installed by the Navy Department, and the radio service on these vessels was until recently maintained by that Department. During the World War there were 44 lightships, including reliefs, equipped with radio, and they afforded useful coöperation. In August, 1918, the Diamond Shoal light vessel sent out radio warnings of a German submarine which was sinking merchant ships off Cape Hatteras. As a result many vessels took refuge and were saved, but the submarine opened fire on the light vessel and sank it.

On October 8, 1916, the crews of a number of vessels of the Allies, sunk in the vicinity by a German submarine, sought refuge on board the Nantucket light vessel, and at one time on that day there were 115 shipwrecked men and 19 boats on the small lightship. The radio was used in summoning assistance and all the men were transferred; had it not been for the light ship most of the men would probably have been lost, as there were gales on the two following days. Within a few years of the first installation of radio on Nantucket light vessel, it was the means of saving all of the crew of that ship. On December 10, 1906, the Lighthouse Inspector at Boston received a radio message from the lightship that she had sprung a leak, the fires were out and assistance was urgently needed. Although a strong gale was blowing, the tender *Azalea* at once proceeded to the light vessel, reaching her early the next morning. After towing the vessel with great difficulty for some distance, it was finally necessary to abandon the ship, which sank 10 minutes after the crew had all been taken off.

Light vessels have on several occasions sent word of fishing boats in distress in their vicinity by means of radio. Several of these light vessels are now equipped with radio fog signals, to assist vessels in steering for them in fog, and others will soon be so provided. A number of light vessels have apparatus so that the crews may receive radio broadcasting programmes. It is intended to extend this system to as many light vessels as practicable, as this will be valuable for instruction, and will do much to relieve the monotony and isolation of those

stationed on light vessels, and will tend to keep the men keen and alert.

LIFE AT THE LIGHTHOUSES

CONGRESS long ago recognized the isolated life of the light keepers by authorizing the supplying of small libraries of books to the stations. This has been done at little expense, as many of the books have been donated. Although the Government endeavors to give every reasonable consideration to the men on the remote stations and vessels, the conditions are sometimes necessarily difficult, as these instances show. The keepers of the Alaska lighthouses at the entrance to Bering Sea remain three years on the stations, getting leave only each fourth year. They have been without mail for 10 months at a time. The experiment is now being tried of installing radio telephones at these stations. At Tillamook Rock Light, south of the Columbia River mouth, there have been intervals of seven weeks when the tender was unable to reach the rock on account of stormy weather. Landing is made on this rock by means of a crate swung out over the boat from a long boom.

For many of the more isolated lighthouses radio would be a great boon to the keepers, as it is to the men on the vessels. The following letter shows how the keeper of a lighthouse on an isolated island in Lake Erie is keeping in touch with the world by means of a home-made radio set:

I thought you might be interested to know that I have a small home-made radio set from which I receive, through WWJ, wireless broadcasting station of the *Detroit News*, the latest world news, the time, reports of sporting events, etc., musical concerts, and a talk every morning by the household editor, giving recipes for each day's dinner, also on the care of flowers and the home. From WCX, of the *Detroit Free Press* station, we hear concerts, speeches, and the news. On Sunday mornings and evenings we hear the services of the St. Paul's Cathedral of Detroit, Mich., through the broadcasting station of WWJ. As we do not get ashore very often we enjoy all this very much. I think a radio receiving set is a wonderful thing for isolated stations.

A number of the lightkeepers are now making and installing their own receiving sets, and the Service will encourage this good work.

Not a Bit Technical

Some Plain Facts About Receivers, Receiving, and Pocketbooks. How to Install Your Antenna and Ground, and What Type of Set to Buy

By ROGER A. WEAVER

TIME and again we hear the radio novice complain about this or that article in a magazine being too technical—"too deep for me," he says. For this reason, it will be interesting to the new listener-in to have the story told him in "plain American" rather than in technical language.

It is doubtful that any one part of a receiving set gets as much *needless* attention as the aerial, or antenna. I say "needless" because the aerial really requires very little attention, despite long arguments to the contrary. Provided with an aerial which is usually credited with being poor, a person who knows how to operate a receiving outfit properly can secure very satisfactory results. Long distances have been covered with good receivers attached to nothing more than a wire fence or even a bed spring or the strings of a piano.

This does not mean that ordinary care should be thrown to the winds when the aerial is put up, nor does it mean that all receivers will operate if merely connected to a wire fence or a bed spring. There are a few simple rules which make possible the stringing of a good antenna in about the same time as a poor one may be set up. Briefly, this is all you need do:

Use copper wire not smaller than No. 18, if you can get it, otherwise use any kind of wire you can procure. If the only wire available is covered, such as bell wire or telephone wire, do not bother removing the covering (insula-

tion) for it will work just as well or better if you leave it on.

Insulators are used to keep the antenna wire away from other objects which would allow the small current, caught by the antenna, to leak off into the ground instead of letting it

pass through the receiving instruments. This means weaker signals and a much shorter receiving range. It is seldom necessary to use more than two antenna insulators and they may be nothing more than glazed porcelain "cleats" and are not very expensive. The pair may be had at any electrical store and should cost less than a dime.

A "lead-in" insulator is a hollow tube, made of some form of insulating material, used to permit the lead-in wire to be brought from outside the building into the

room where the receiver is to be set up, without letting it come in contact with the building itself. A lead-in insulator may be nothing more pretentious than a porcelain tube, six to ten inches long. Such tubes are often used in regular electric light wiring and may be had for about a nickel at most electrical stores.

Lightning arrestors are used to protect the buildings, in which radio sets are installed, from fire due to lightning. You should procure one which has been approved by the National Board of Fire Underwriters. They range in price from one dollar up—the dollar kind are just as effective as those that sell for considerably more.

Choosing a Receiver

If you are among the throng who stand undecided, on the threshold of radio; if you are one of the millions who have listened to the spirits singing and laughing and playing about them by the use of a simple radio receiver; or even if you are an enthusiast with a long line of distance records to your credit, you will find interest in this article. We quote from it the following paragraph:

"Your choice of a receiving set should be made according to the distance over which you desire to receive as well as with relation to your pocket-book. It may be well to point out, in a general way, what you may expect from any of the seven types of receivers in common use. An intelligent selection may save you a considerable amount of annoyance and money, and much satisfaction may justly be had in being able to do for little what a neighbor has only been able to do for much."—THE EDITOR.

You will need a "ground" wire to connect between your ground and the lower terminal of the lightning arrestor and the "ground" terminal of the receiver. The most suitable wire for this purpose is copper wire, not smaller than No. 18. It should be insulated.

In putting up the antenna, you should bear in mind that height lends distance to your "view"—height above surrounding objects, not height above sea level. Seventy-five or one hundred feet of wire in a straight line, thirty or more feet above the earth or other objects, makes a good antenna for broadcast reception. The insulators should be used as shown in the

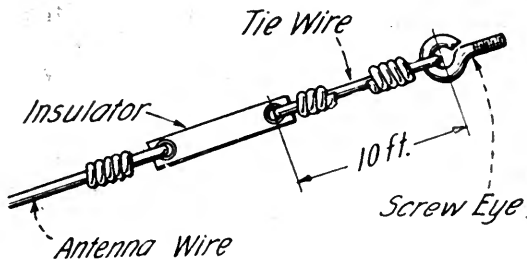

CONNECTIONS AT THE FAR END OF THE ANTENNA

accompanying illustration, and the antenna wire should always be ten feet or more from any other object.

The lead-in should be taken from a point on the antenna-wire some distance from the building in which the receiver is, so that it will not come near the house except where it enters the lead-in tube. With these few things in mind, put your antenna up where it is most convenient.

THE GROUND

IT IS not uncommon for people who spend a long time getting their antenna up to show no appreciation for the value of a good ground connection. Connect to a water pipe if one is available. Use a "ground clamp," scraping the pipe first with a rough file to be sure of a good connection.

If a water pipe is not available, good results may usually be obtained by connecting to the piping of a steam or hot-water heating plant. Where these are not to be had, a pipe driven five or six feet in the ground just outside the house will do, but the results will not be as good. *Do not connect to gas pipes.*

The wire from your ground connection to the receiving set should be as short as possible and it is usually a good idea to have the receiving set as near the point where the lead-in wire

enters the building as is convenient. Wires leading from the lightning arrestor—which may be mounted on the wall inside the house if no transmitter is used—to the antenna and ground terminals of the receiver, should be short.

VARIOUS KINDS OF RECEIVING SETS

YOUR choice of a receiving outfit should be made according to the distance over which you desire to receive as well as with relation to your pocket-book. It may be well to point out, in a general way, what you may expect from any of the seven types of receivers in common use. An intelligent selection may save you a considerable amount of annoyance and money, and much satisfaction may justly be had in being able to do for little what a neighbor has only been able to do for much.

CRYSTAL RECEIVERS

IF YOU live within 25 miles of a good broadcasting station and there is no reason why you cannot put up a good antenna—a single wire 75 to 100 feet long and 30 or more feet high—you may be satisfied with the results which a crystal receiver will give. However, many owners of crystal receivers, living within ten miles of a broadcasting station, find it difficult to receive satisfactorily, especially in the summertime.

In addition to the meagre range of the crystal receiver, it is subject to a great deal of interference from undesired stations. This is particularly true in seaports where the spark transmitters on shipboard cause much tearing of hair among those who would listen-in.

There is little difference to be found in the performance of the various crystal receivers, though there is a very great variation in the prices asked for them. The most essential element in this form of receiver is the crystal itself and the ability of the operator to locate its sensitive points. Most of the difference in various sets of this character is found in the workmanship and the materials used in manufacture. It is not an uncommon occurrence for the youngster who makes his own crystal receiver from an oatmeal box, some bell wire and a good piece of galena, to receive over longer distances than the users of far more expensive outfits.

Second in importance to the crystal are the telephone receivers. It should be borne in

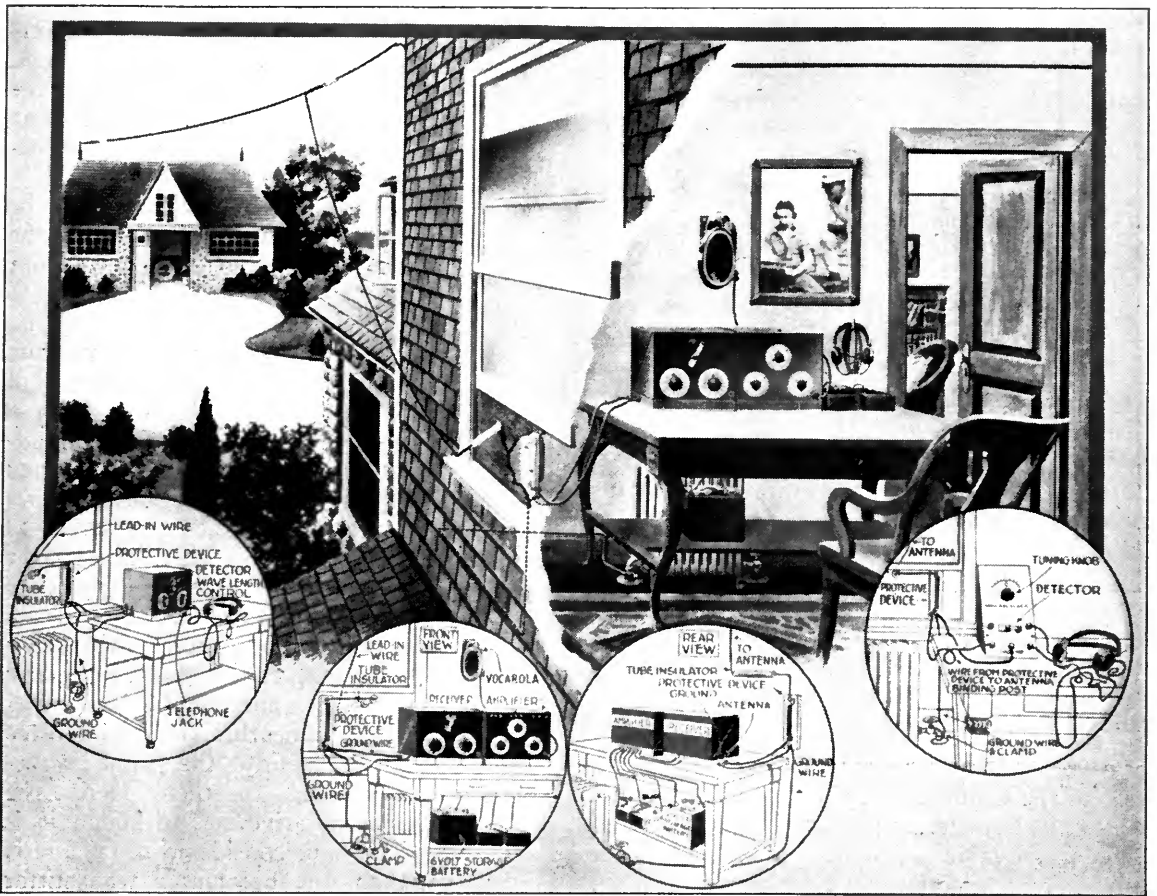

Courtesy of Radio Corporation of America

SHOWING HOW THE ANTENNA AND GROUND ARE INSTALLED

The porcelain lead-in tube is set into the window-board at an angle, so that rain will not enter. Note that the lead-in does not come close to the house except where it enters the tube

mind that the head-phones are a considerable item, when you purchase a complete crystal receiver. A difference in the choice of phones may make the difference between satisfaction and disgust.

There are many circuit arrangements used in crystal receivers, and much is claimed for each of them, but in the final analysis, there is mighty little difference in the average performance.

VACUUM-TUBE RECEIVERS

THE selection of a vacuum-tube receiver is a rather serious proposition and it is likely to be expensive unless you know just what you want before going into the market. So many combinations are possible with vacuum-tube receivers that it may be well to classify them briefly and then discuss each class in its turn:

TYPE	AVERAGE RELIABLE RANGE	COMPLETE PRICE
Single-tube, non-regenerative set	25 miles	\$ 45-\$ 60
Single-tube, single-circuit, regenerative set	50 miles	\$ 50-\$125
Single-tube, three-circuit, regenerative set	50 miles	\$115-\$150
Two-stage audio amplifiers for above, increase price		\$ 60-\$ 90
Loud speaker increases price		\$ 15-\$162
Radio-frequency amplifiers increase range materially, and the price		\$ 50-\$100

SINGLE-TUBE NON-REGENERATORS

MOST of the receivers made for use with a single tube in a non-regenerative circuit have been designed for the use of standard vacuum detector tubes, like the Radiotron UV-

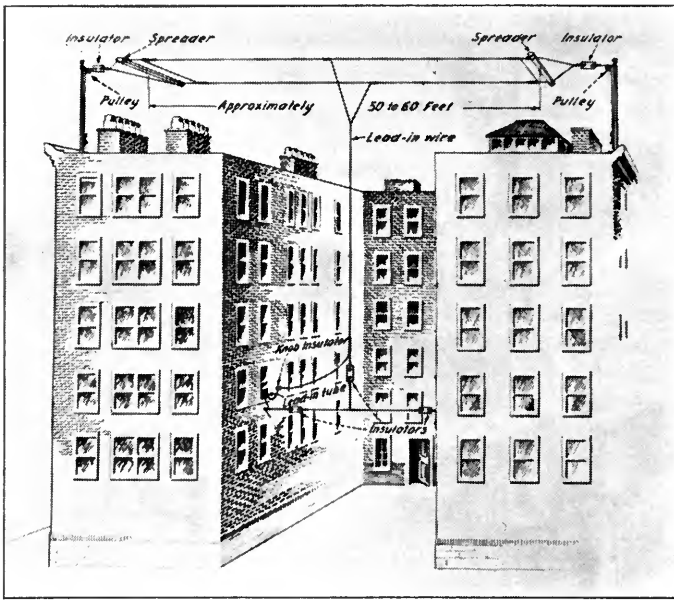

ON APARTMENT HOUSES

The erection of an antenna may be a difficult job. Even though every precaution is taken, the "cliff dweller" has a hard time competing with his country cousin. This picture shows how a lead-in may be held away from the walls of the building, in cases where it has to be brought down a shaft or into a court

200 or the Cunningham C-300. Some employ a so-called single circuit, while most of them have a movable secondary, providing better tuning and selection by altering the position of the secondary with relation to the primary.

The single-circuit, non-regenerative receiver is but little better than a good crystal outfit, though it is much more expensive and troublesome. Single-tube non-regenerative receivers of either of the above types are nearly as costly and not as satisfactory as the next class, which is very popular among those who desire a long range, comparatively strong signals and comparatively good selection power—that is, the power of being able to hear the desired and weed out the undesired stations.

SINGLE-TUBE, SINGLE-CIRCUIT REGENERATORS

FOR simplicity of operation it is doubtful whether any form of regenerative receiver may be had that compares with the single-circuit regenerative receiver. Most of these receivers are made with but three major controls, one for controlling the brilliancy of the vacuum tube, one for regulating the wavelength, and one for controlling the degree of regeneration, which makes the received signals louder or weaker.

In addition to the major adjustments, the better quality receivers are provided with "verniers" used for making delicate changes in the major adjustments. Where long distance and good selection are desired, verniers are necessary.

Receivers of this class may be procured with or without the vacuum-tube control apparatus, but those with the tube control are to be preferred and are usually no more expensive than the two units purchased individually. Some of the best results obtained from a single vacuum tube used for broadcast reception have been obtained with single-circuit regenerative receivers.

However, this class of receiver has a weakness not shared by types which are a little harder to learn to operate but more satisfactory in the long run. This is especially true when a number of broadcasting stations of nearly the same intensity and on nearly the same wave-

length are operating together. Here, the single-circuit regenerative set, although it is the best type we have considered so far and is in very common use, becomes a transmitter when in the hands of a person not familiar with its proper manipulation, and causes shrieking and whistling in other receiving sets in its vicinity. Several receivers of this type can create quite a hub-bub if operated near each other. There are those who would abolish this form of receiver, because of its ability to transmit, but no such action has been taken as yet.

SINGLE-TUBE, THREE-CIRCUIT REGENERATIVE SETS

FOR the person who is willing to spend a short time in learning to operate it, there is no receiver employing a single vacuum tube which can hold a candle to the three-circuit regenerator. It is a little more expensive than the receivers we have been considering, but the results which can be obtained from it are surely worth while.

There are three classes of three-circuit regenerators on the market and they are all good. We have those made with lattice-wound or spider-web coils; those employing a condenser

for tuning the secondary circuit; and those utilizing a variocoupler and two variometers. Each type has its group of supporters. Most of them swear by their choice, and at the other two. They all have their individual advantages, but you are safe with any of them. My own preference is the variocoupler and twin variometer arrangement.

Three-circuit tuners provide the best method of receiving what you want to hear and eliminating what you don't want to hear (with a single tube), that has so far been developed. The slight difficulty experienced in learning to operate them is well repaid by music and speech being received with a minimum of interference.

In purchasing a three-circuit receiver you should be sure that it is provided with verniers, which aid greatly in making delicate adjustments. Other factors for you to consider are material, workmanship and ease of control. It is better to buy a good receiver than a makeshift.

AUDIO-FREQUENCY AMPLIFIERS

IT IS sometimes desirable to increase the volume of the signals that a single vacuum tube gives you, in order that a loud speaker may be used instead of the telephone receivers. *A loud speaker cannot be used without amplification.* Two stages of audio-frequency amplification are generally necessary. Using the amplifiers increases the volume of the received signals, but does not increase very much the *distance* over which you can receive.

There are a few important facts to remember concerning this form of reception. Knowing the limitations may save you some acute disappointment as well as the useless spending of considerable cash.

An audio-frequency amplifier is used to increase the volume—not the distance. An audio-frequency amplifier may be used with any of the receivers we have considered and any signal loud enough to be heard easily

without an amplifier may usually be heard over an average-size room when a two-stage amplifier and loud speaker are provided. A good two-stage amplifier may be had for about \$45, but that is not all you need.

A two-stage amplifier means that you must use two more vacuum tubes, additional B batteries and it is usually better to use a larger storage battery for lighting the filaments. The additional tubes should be amplifier tubes, not detector tubes, and they may be had for about \$6.50 each. At least two additional 22½-volt B batteries should be procured.

The storage battery used with a three-tube receiver should have a capacity of not less than 100 ampere hours unless the new uv 201-a tubes are used. This is especially true if the loud speaker is one that requires a connection to a six-volt battery.

If you purchase a single-tube receiver, and expect to add the amplifier and loud speaker at a later date, you will save yourself trouble and expense by purchasing a 100-ampere-hour storage battery in the beginning. You may meet a clerk who will argue that a 40- or 60-ampere hour battery will do, especially if you have your own charging apparatus, but don't

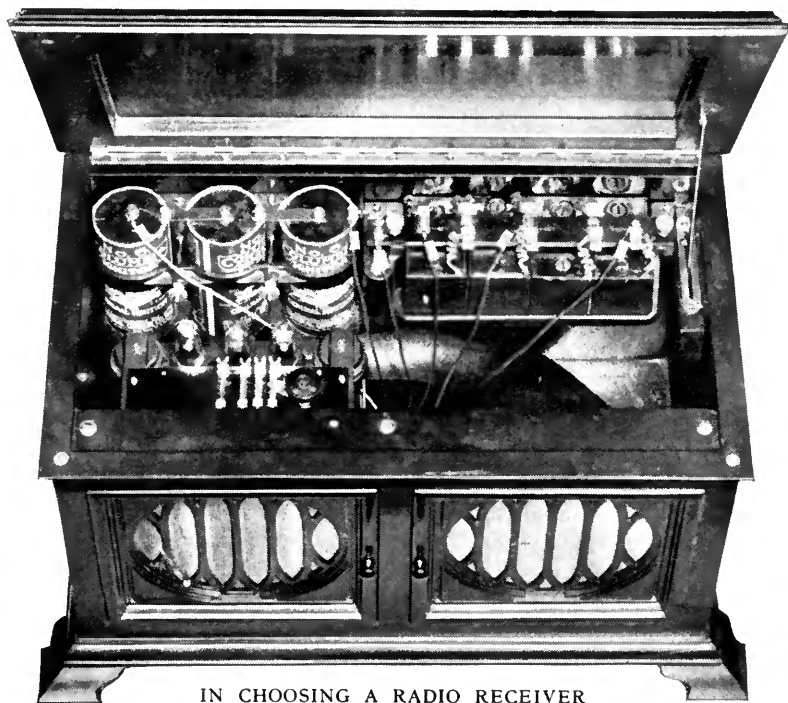

IN CHOOSING A RADIO RECEIVER

It is well to investigate the possibilities of outfits like this. Here we find everything—tuner, tubes, amplifier, loud speaker, and the necessary batteries, all within the cabinet, which is not too large and presents an attractive appearance

let him best you, for you are sure to be disappointed. A well charged storage battery is necessary for good operation, and the larger size will hold its charge under heavy duty for a longer period than the smaller one.

RADIO-FREQUENCY AMPLIFIERS

ALL sorts of claims are being made for receivers employing one or more stages of radio-frequency amplification and many of these claims are absolutely trustworthy. However, unless you have had some experience in manipulating ordinary receivers, radio-frequency amplification is likely to cause you a lot of worry and give little satisfaction. It always means several extra adjustments, as well as more delicate manipulation of the other units in your receiver. More than two stages, except in the hands of an expert, are quite likely to do more harm than good.

By the proper use of radio-frequency amplification, it is possible to receive over about the same distance with a loop antenna as is ordinarily possible with the detector tube alone, when an outside antenna is used to feed a regenerative receiver. Radio-frequency amplification is used to increase the distance over which a receiver will operate—not to increase the volume of sound produced by the receiver.

If you are just beginning your voyage on the good ship *Radio*, you will do well to leave radio-frequency amplification, loop aeri-als and super-regeneration alone until you have learned some of the peculiarities of vacuum-tube reception with a regular antenna. On the other hand, if you have finished your first cruise and desire new oceans to explore, the brevity with which the subject must be treated in an article like this would make it almost useless to you.

DRY-CELL TUBES

YOU may use dry-cell tubes (which make the six-volt storage battery unnecessary and are usually as satisfactory as the standard tubes) in any of the receivers described above, and their use cuts down the cost of a receiving outfit in a way that warms the cockles of the hearts of the thrifty.

As its name signifies, the dry-cell tube is operated from a single dry cell, and such a cell will last about a month, under ordinary operating conditions, when a single tube is used. Where more than one tube is used, an addi-

tional dry cell should be added for each additional tube. For instance, a receiver employing a detector and two stages of audio-frequency amplification should be supplied with three dry cells, connected in *multiple* (in parallel). Multiple connection merely means that all the positive, or centre terminals, are connected together and all the negative, or outside terminals, are connected together, and then one negative and one positive terminal are connected in the filament circuit just as if only one cell were used.

Dry-cell tubes perform nicely as detectors but are not uniform in operation when used as amplifiers. Some require a great deal more plate voltage than others, but three variable B batteries are generally capable of supplying the voltage desired.

DOLLARS AND CENTS

LET us see the difference in cost between a set employing standard tubes and one employing dry-cell tubes:

UNITS	STANDARD	DRY CELL
Antenna Equipment	\$ 5.00	\$5.00
Tuner (three-circuit)	70.00	60.00
Amplifier (two-stage)	40.00	40.00
Loud Speaker	20.00	20.00
Detector Tube	5.00	8.00
Amplifier tubes (2)	13.00	16.00
A Battery	35.00	1.20
B Battery (3)	6.00	6.00
	<hr/>	<hr/>
	\$194.00	\$156.20

Here we find a saving of \$37.80 in favor of the dry-cell outfit, but that is not the only saving. The three dry cells used for the A battery, at a cost of \$1.20, will last considerably longer than a single charge of a 100-ampere-hour storage battery. To have the battery recharged will cost \$1.00, to say nothing of the inconvenience of getting it to and from a charging station. If you figure on charging it at home, add \$15 to the cost of your standard outfit for a battery charger.

Of course these figures can be altered by a little "shopping" and the more you do the more you will find in favor of the dry-cell outfit. Doing so will help you to make an intelligent selection of equipment and may help you to avoid a "severe financial crisis."

Teaching the Chinese Radio

By ROBERT F. GOWEN

Consulting Engineer

THE great republic of China is dependent upon two factors for its coordination, and the lack of these is responsible for the so-called civil war which exists at the present time between the North and the South. One of these is transportation and the other is communication. Both are vital factors in unifying the people of such a vast country. At present, transportation facilities are confined to the rivers and to narrow stone walks over which coolies carry merchandise on poles from one village to another. Communication consists of a string of inefficient telegraph lines, with extremely bad facilities for telephoning over a limited area in the large coastal cities. The result is that inland towns and villages are cut off entirely from the active export centres.

It was with the communication problem in South China that I was fortunate enough to be connected during the past year. In October, 1921, I was given three days' notice to pack up and leave New York for Hong Kong, to remain in the Orient for at least a year. This rather brief notice required considerable action and was further complicated by my marriage, which took place an hour before our departure. After weathering a hurricane on the Pacific we arrived at Yokohama, spent three days in Japan, a day in Shanghai, another in Manila, and reached Hong Kong on November 4th. There I received orders to proceed to Canton, where I found that a man connected with the American engineering organization

which had engaged my services was about to leave after nine months of trying to give the Chinese radio communication, without result. The problem was one of eighteen one-kilowatt telephone and CW telegraph installations, with gas engines and storage batteries for the power supply. I found the equipment in terrible condition, gas engines broken, batteries sulphated and motor generators full of moisture and burned out. The radio equipment which I had designed and built some two years previously for the De Forest Radio Telephone and Telegraph Company was almost unrecognizable. There was a quarter of an inch of green mould on all wires and the parts were so corroded that



AN INTERESTING-LOOKING STREET IN OLD CANTON

they were almost black, while the coils were full of moisture so that in some cases their finewindings were loose and their insulation completely gone. The one-half kilowatt oscillion tubes were even worse. Of the eighty that were shipped I found but forty, and on inspection and test I discovered that most of these were smashed, leaky or soft. In fact, there was but one tube in the forty that was commercially workable for telephony, although two other soft tubes could be used on low power for test purposes.

It was evident that my first step was to re-condition the material. I found an interpreter in the person of a young lad who had learned some English in a Chinese school in Hong Kong and with him rounded up two or three so-called Chinese mechanics. The problem was rather staggering as there were no tools to work with and it was impossible, of course, to obtain standard parts or such things as American machine screws, nuts, etc., which the sets required. The saving grace was a former Navy operator named Leslie Grogan, who had arrived at Canton three weeks before me. He, with a young English boy who knew nothing about radio, had been trying to make some headway, but did not get far as unfortunately Grogan had had little experience with continuous-wave transmitters. He knew gas engines and storage batteries, however, and was invaluable to me in conditioning those on hand. My first official act was to discharge the English lad, who proved to be worthless, and to make a trip to Hong Kong where I bought all the tools that were available. Grogan was then assigned to the engine and battery work while I, through my interpreter, by manual illustration, attempted to teach the brightest of the Chinese "mechanics", Mr. Wu, how to put the radio

equipment into workable shape. This was a long drawn out process. It meant tearing the sets completely to pieces, boiling out coils in beeswax and resin and rebuilding them from the bottom up.

In a few weeks we had equipment ready for an installation and started to place it in the master station known as "Canton Central" in the city. I immediately found that the aerial must be taken down as the joints were not even soldered, a new ground must be installed and even the wiring to the motor generator set had to be renewed as it was improperly installed and not of sufficient capacity to carry the required operating current. The result was that the station had to be rebuilt throughout, but as we had new equipment ready for the job, it was but a question of a week or ten days before it was completed and in working order. At this point the day was again saved by the arrival of a Chinaman from San Francisco with

Who the Author Is

If you are an "old-timer," Robert Gowen needs no introduction. Possibly you have listened to some of the broadcasting he did in 1920 from 2XX, at Ossining, N. Y.

In 1902, Mr. Gowen built a receiver and transmitter himself. From that time to the present, he has always been an ardent "ham" and has filled many important posts. He was attached to the Engineering Department of the American Telephone and Telegraph Company from 1909 to 1912. In 1918 he was made Designing Engineer of the De Forest Company after about a year with the company as a laboratory assistant. In 1921 he became Chief Engineer and Plant Manager. During the same year, Mr. Gowen took over the duties of Consulting Radio Engineer for Davis Co., Ltd., of Hong Kong, China.

Mr. Gowen is responsible for a number of improvements in radio, such as the honeycomb coil and coil mounting, the vernier condenser, etc. At present, he divides his time between work in his laboratory and the consulting practice he has established since his return to this country.—THE EDITOR.

two more De Forest equipments for which he had brought eight standard oscillion tubes. After some negotiations four of these tubes were purchased from him in order that we might go ahead with the other stations.

As soon as the defective equipment was removed from the Canton station we immediately went to work and conditioned it for the station at Shui Chow, 140 miles north. This took several weeks, at the end of which time we hired a freight car, loaded about a ton of apparatus aboard, took along a Chinese cook, my interpreter and mechanics, camping outfits and food, and after bumping over the rails for a full day on the only inland railroad in South China, reached our destination. It was then necessary to transport this heavy equipment from the freight car to the radio



MR. GOWEN AND HIS SCHOOL

These thirty young men of Canton, exasperatingly slow to learn at first, finally became so proficient that they constructed, by themselves, a complete radio telephone station, which they showed their teacher with great pride on "Commencement Day"

station located in an old temple on a hill about a mile away. This was done by forty coolie women who were happy to receive ten cents each for lugging such things as motor generators a mile up the hill.

Like the Canton station, this one was also found to be in very bad condition, improperly arranged and connected so that rebuilding throughout was necessary. The gang worked early and late, however, and in a week I returned to Canton to open communication with Grogan at Shui Chow. The day before Christmas, telegraph communication was established, and telephony was tested out with excellent results, but was immediately discontinued because of lack of proper oscillation tubes. These stations, together with two smaller ones which we had rebuilt and established in the meantime, were then turned over to the Government, which manned them with the operators whom they had retained to work some old Telefunken spark equipment which the Germans had installed for them some ten years previously. Conditioning of the equipment from Shui Chow then began, but it was impossible to go

further with installation because of lack of tubes.

While these negotiations were in progress some difficulties arose with regard to payments by the Government to the American concern which had retained me, with the result that the Government decided to take over the equipment and do the installing in the future themselves with their own mechanics and so-called engineering force. I was much surprised to learn that their new plans included taking me over with the material.

Like everything else in China, business negotiations move at a snail's pace and it was therefore not until the first of January that I found myself officially appointed Chief Consulting Engineer and Technical Advisor to His Excellency Chung Kwing Ming, Governor of Kwangtung Province. The appointment was the result of many conferences with Chung Yuk Hang, the Director of Communications, the Chief of Staff and others, and it was most surprising that I got it at all, for the Governor's original idea was that I should continue to build stations, using the Government's employees just as I had been doing previously with the

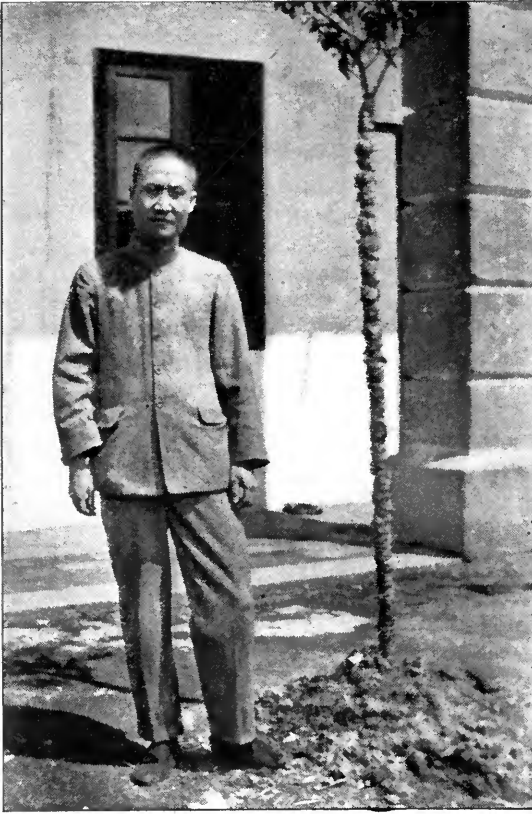

MR. CHUNG YUK HANG

Director of Radio Communications. He didn't know a vacuum tube from an inner tube but he held down the job with assurance and distinction

American concern. I argued that this was out of the question as the Government did not have the personnel, materials, transportation facilities, or the testing equipment for the work; that it was impossible for me to build the four stations already finished in a month and a half without the aid of Grogan and a force of intelligent mechanics whom I had trained with much difficulty and at great expense. The Government refused to take over this staff with me on the ground that the expense was unwarranted in view of the fact that they had mechanics and I therefore proposed that instead of building stations for them I teach their operators and mechanics how to build future stations and maintain and operate those already in existence. I also insisted that they allow me to retain Mr. Lowe as interpreter and Mr. Wu, my chief mechanic, in order that I might supervise putting the remaining equipment into shape. This they finally agreed to do.

Accordingly I set to work writing a textbook

for them which Mr. Lowe translated into Chinese. Both versions were mimeographed and made up into books so that each scholar might have his own. This work took several weeks and proved to be exceedingly difficult, as I found that the Chinese had no characters with which to represent technical phrases. Therefore it was necessary for Mr. Lowe to translate my English version into Chinese and read it back to me, after which I would alter and simplify it into such English words as he could readily grasp and retranslate into Chinese.

In the textbook, though it dealt of course with strictly technical things, I was obliged to use the simplest kind of primer phrases, as I was dealing with men who knew as much of electricity as an American child of about ten years of age. For instance, when I talked about the armature of a generator, Lowe would translate it back to me from his Chinese version as a "ball of wire" and state that this was the nearest translation he could get for the term. This was all very well, but I found that he was translating the terms "Honeycomb coil, grid choke coils, transformers," etc., also as "balls of wire." Accordingly, it was necessary to supplement the Chinese translation with the proper technical term in English in order to differentiate between these types of windings, which, of course, function differently in each case.

I opened school with thirty pupils including Chung Yuk Hang, the Director of Radio Communications, and Mr. Fung, the Assistant Director. The first day of it nearly killed me. I lectured through an interpreter for two hours in the morning to this group of earnest but none too intelligent students, using a blackboard for illustration, and when I finished I hadn't the remotest idea whether or not they had the slightest conception of what I had said. Their blank, immovable expressions gave no hint of what, if anything, was going on within their brains and the effect on me was as if I were talking to a stone wall. It was exasperating, to say the least, and the effort in racking my brain over and over again for a different means of expression that they might understand through the interpreter was very fatiguing. I divided the class into groups and gave them laboratory work in the afternoon and instruction on the actual mechanical arrangement of the apparatus, insisting that they connect it and disconnect it until they had become ac-

customed to the handling of the different controls.

The second day I gave them notebooks and asked that they keep them and write notes of what I said as best they could. This scheme worked and I soon found by having Lowe translate their Chinese notes back to me that they were actually getting something. They reproduced the drawings that I made on the blackboard accurately and eight of the class who could write a few words of English were noting in English the technical terms that I was giving them in addition to the Chinese interpretation.

Then I tried examinations and struck another snag as they positively refused to take exams on the ground that they were not being paid enough to do so much extra work. I argued that I could not tell whether they were learning anything or not without these examinations. They then put up the defense that it was dishonorable, according to their code, for one man in the class to be compared to another by the result of examinations when they were all being paid the same wage. For several days I argued and insisted, but finally brought them to my way of thinking by convincing them that coöperation with me would benefit them to

such an extent that their wages would in due time be increased.

The first examination papers as Lowe translated them to me were certainly hopeless, but I could see that I was on the right track and took occasion to humor them by marking them high and complimenting them on their good work. The result was that I had no further difficulty with the examinations until the final one at which they balked *en masse*. I was very much discouraged at this, as the weekly examinations had been growing markedly better each time and their notebooks had improved wonderfully. Their argument this time was that the final examination would determine who should and who should not graduate, and they would not agree to such a distinction, as all must graduate in order to be retained in the Government employ. It was not difficult to see their point, yet I felt a final examination was essential in order that the Director might have a comparative standard by which to pick men to whom he could entrust the direction of future work. I therefore insisted that they take the examination and set aside a certain day for it. I opened school as usual and not a soul appeared. All I found was a note from one of the star pupils, as follows:



THE DIRECTOR OF RADIO COMMUNICATIONS AND THE STAR PUPILS

In this group, left to right, we find: Messrs. Wu, Chief Mechanic; Si Tot, a star pupil; Fung, Foreign Correspondent, Radio Dep't. (so elected because he could write a little English); Lowe, interpreter to Mr. Gowen; another star pupil; Chung, Director of Radio Communications; two more star pupils; and Chung (another Chung: this seems to be the "Smith" or "Jones" of China), Assistant Chief Engineer, who helped also as interpreter



THE VASE PRESENTED TO MR. GOWEN

By his class of Chinese radio students. It is made of silver and carries elaborate designs and inscriptions. Three Oriental gentlemen on the front represent Long Life, Good Luck, and Happiness. On the opposite side of the vase is a stork bearing a diploma

“Mr. R. F. Gowen,
Sir:

As I am returning to my ship for some pressing business, I regret very much that I can't attend this examination and your favorable excuse will be much obliged by,

Yours obediently,
Ng Lau-Cheong”

I therefore posted a notice on the blackboard that the examination would be held the following day instead. The result was that the class appeared next morning full of apologies and stated that their non-appearance was due to the fact that they had to spend the previous day in forming a union by which they might appeal to the Government for better wages.

Needless to say, everyone passed the final examination but not all with the same degree of success. The results, however, were beyond my expectations and were very gratifying indeed. In order to ascertain what they knew

about the practical work, I had given them orders actually to construct in every detail a complete station in the laboratory without my assistance. It was a great event when they ushered me in on commencement day and showed me with triumphant pride what they had accomplished.

The events of that commencement day are a story in themselves and the banquet and “send off” they gave me will always retain a place in my memory. A volley of presents was exchanged on both sides, according to the Chinese custom. On the beautifully engraved silver vase which was given me by the class, was an inscription which was translated for me by Fung Shin Suan, as follows:

Unusual works, if never done before, will not appeared comparatel better; and, if not be continued by the others, will not be known for its success. As the Radio-service in Canton had its progress so limited, Director Chung has the desire to have its enlargement, and therefore many outlying stations have been established somewhere, and many newest Radio-telephones of De. Forest system, have installed. Mr. Gowen, the radio expert of U. S. A., has been appointed to be the Chief Engineer and also the of the Radio-telephone educating cause and have done his utmost to our satisfaction. Now, the valuable cause is compered and he will go apart somewhat different from being accompanied in the same place, and this present is asked to be accepted for our ever remembrance.

31st., 3rd., 11th. C. R.

By The staffs of the Radio Comm. Dept.
Canton, China.

Here is the letter he wrote in English to accompany the vase:

The Republic of China
Radio Communications Department
South Bund, Canton, 1st 4th 1922

To Mr. Gowen,
Sir,

I, with the most honorest, send you a vase and a photo, of which I beg your kind acception.

On the surface of the vase, the Chinese composition, I have translated into English by my simple knowledge, and the appearance of all of us in the photo, will both cost your ever remembrance in my foolish anticipation.

With best compliment to Mrs. Gowen,

I am

Your obedient student
Fung Shin Suan.



The Navy's Example in Standardization

By COMMANDER STANFORD C. HOOPER, U. S. N.

Head of Radio Division, Bureau of Steam Engineering, Navy Department

ONE of the fundamental essentials in the supply and use of any mechanical device is an early and thorough consideration of standardization.

In nearly every new trade, however, consideration of nationwide standardization is made secondary to less important yet seemingly more urgent factors, and the trade in the particular device grows along the lines best suited to satisfy immediate demands, without particular regard, on the part of the company putting the article on the market, for future replacement of worn-out parts and present reduction in manufacturing costs. Also, competitors in furnishing machines designed for similar use have an inherent antipathy to making any parts interchangeable with those of their competitors.

All this is very natural, but there are many cases in which, if a little forethought and additional effort had been

made, the public would be saved financial loss and much discomfort, had the manufacturers taken pains to foresee the time when their machines would begin to wear out and the difficulty the consumer would have in obtaining spare parts.

Standardization

At the time we entered the war our radio equipment was anything but standardized and it was necessary for our Signal Corps and the Radio Section of our Air Service to carry on much of their work with apparatus obtained from the Allies.

The truth of the matter is that very little American radio material was in operation in the Advance Zone of the A. E. F. prior to the signing of the Armistice, and much of the equipment in the training schools in the Service of Supply was of French or British manufacture. We can ill afford a second experience of this nature.

Commander Hooper is in charge of that section of the U. S. Navy that draws the specifications for our Naval equipment and the equipment used on the vessels of our emergency fleet. His view-point should be of interest to all those who follow radio, especially at this time, following the conference called by the Bureau of Standards to standardize radio manufacture at the joint request of The Institute of Radio Engineers, National Radio Chamber of Commerce, Radio Apparatus Section of Associated Manufacturers of Electrical Supplies, National Retail Dry Goods Association, American Radio Relay League, and Radio Corporation of America.

—THE EDITOR.

Take the automobile industry as a glaring example. Of course, in recent years considerable standardization has taken place between competing makers of nearly all classes of motor cars. But we can all remember how, until quite recently, hardly anything which one particular make of car needed could be obtained at the average automobile supply shop, unless the car was one of the few in most general use. And yet there was no real advantage to the automobile manufacturer in not using standard tires, wheels, battery sizes, fan belts, etc. In fact, the earlier the manufacturer realized

the advantage in using the same standards as the majority, the earlier the public became

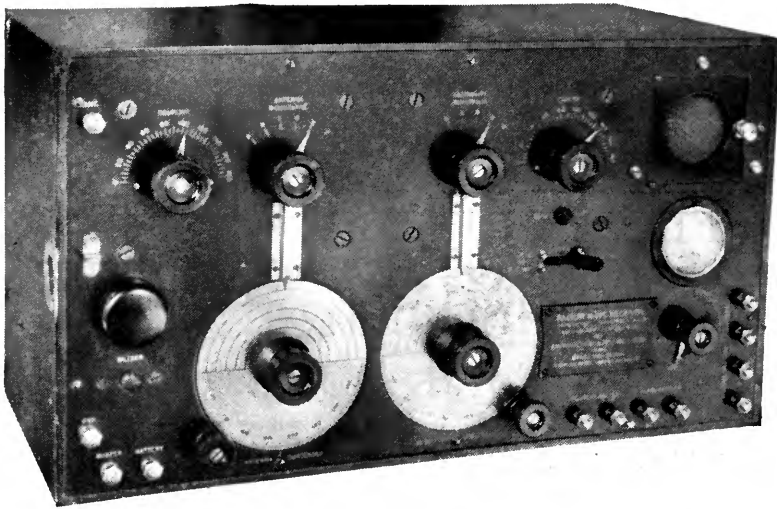

RECEIVER MANUFACTURED FOR THE NAVY IN 1920

Most of the mountings on this set have been standard for the last eight years

cognizant of the fact that his particular automobile was preferable to another make for which spare parts could not be obtained at almost any automobile accessory shop along the road.

The points which the careful buyer inquires particularly about, in purchasing an automobile to-day, are initial cost, upkeep, appearance, comfort, durability and "Can I get spare parts anywhere along the road?" In many cases where competition is keen, the latter point is the deciding factor.

Not only from a point of view of salesmanship, but from a point of view of duty to the public, manufacturers should keep in mind the importance of standardization. Is it fair to sell a poor boy a radio set which he has saved his money for months to buy, and then have him find, after a month or two of use, that it would cost nearly as much as the initial price of the set to replace one particular part?

Probably one of the best standardized

trades to-day, and yet one of the youngest, is the airplane industry. The desire to standardize came after the outbreak of war, rather than before. In regard to airplane motors and parts, the standardization of these was finally given such importance that the heavier-than-air production programme was greatly delayed in order to secure standardization, and our military forces were seriously hampered in their final work of winning the war. This was a prominent example in which standardization was so delayed that the nation's interests suffered. You and I are paying

taxes to make up for the nation's lack of foresight in matters of this nature.

There are numerous examples in other phases of our military work in the great war where the

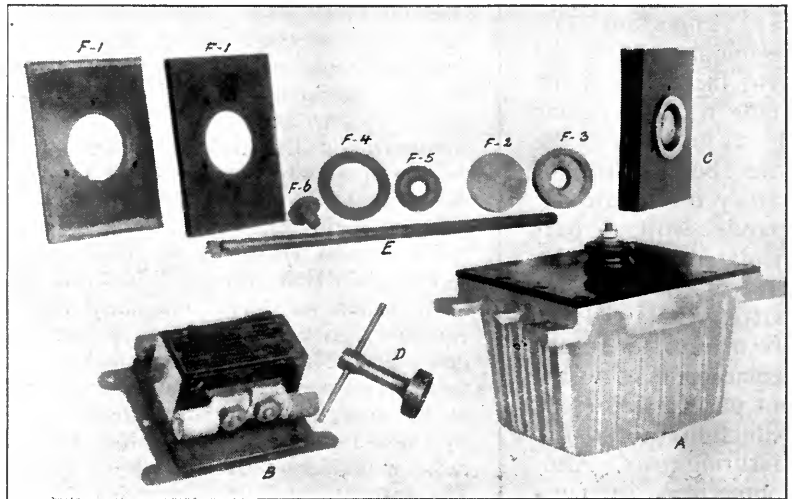

INTERCHANGEABLE UNITS FOR NAVY APPARATUS

These parts, designed for the 1-KW set, may be used equally well with the 2, 5; or 10-KW transmitters. A—Mica condenser, B—Protective device, C—Quenched gap (assembled), D—Quenched gap wrench, E—Quenched gap test rod, F—Quenched gap unit (apart), 1—Cooling flange, 2 and 3—Hub and electrode, 4—Gap gasket, 5—Bolt gasket, 6—Bolt

failure of standardization in advance caused great delays, delays which might have resulted in our paying taxes to the Kaiser had they been a little more serious. The Germans, in their

preparedness, had well considered the value of standardization as a military necessity, and were not handicapped in this respect as much as the United States and its Allies.

There are three important reasons why standardization in industry is essential:

(1) Those who standardize have a natural advantage when it comes to selling their goods.

(2) The duty to the public.

(3) The duty to the nation, in being better prepared for war.

The first reason will appeal at once to the average business man, and he will give this point serious consideration. It is a matter that he will handle on his own initiative.

The second point he may think worth while, and he will probably cooperate in it if some patriotic organization perhaps will prepare the machinery and red tape for making standardization easy. This matter could be taken care of by some such organization as the Radio Chamber of Commerce, a radio manufacturers' association, or possibly by the encouragement of the Government through the Department of Commerce.

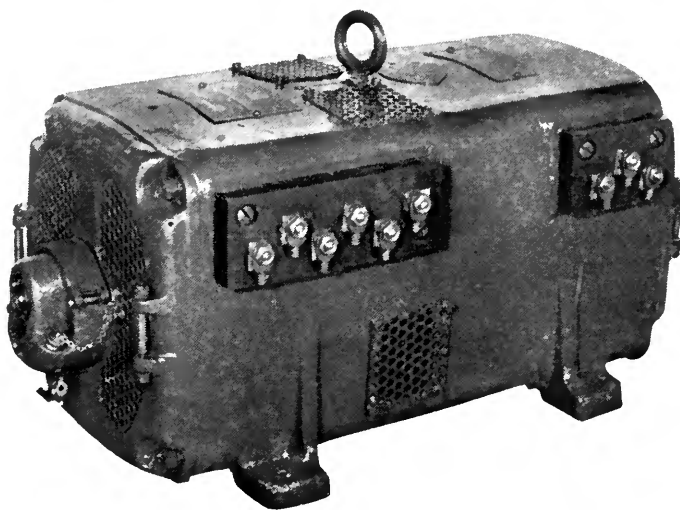

A 2-KW 500-CYCLE MOTOR-GENERATOR

The terminal boards and fittings of this model are interchangeable with the corresponding parts of the 5 and 10-KW generators

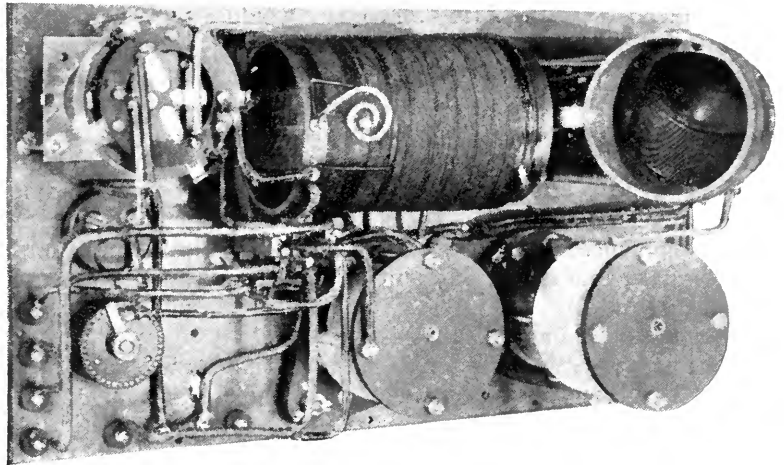

BACK OF RECEIVER SHOWN ON OPPOSITE PAGE

The vacuum-tube socket and the two condensers are standard pieces of equipment

The third reason is one from which results will be obtained only through the efforts of a few of the more patriotic manufacturers or through the constant efforts of the Army and Navy. The function of a military service is to keep prepared for the defense of a nation. This preparation includes not only the number of men, ships, and munitions in the actual service of the Army and Navy but the skill of the organization—the men behind the guns.

The World War was a lesson from which all thinking men naturally draw their own conclusions about such matters as the value of organizing private manufacturers as an aid to the military along definite prearranged lines. The reason is now perfectly clear.

As inventors, designers, and distributors of radio sets, any representative assembly of the radio profession might well give serious thought to the necessity for peacetime standardization if for no other purpose than to assist in preparedness, even though other reasons for such action do not appear sufficiently important. In a republic, with all its superior blessings, we are prone to pay vast sums in taxes after a war in defense, rather than in advance at a time when a much smaller sum would have been necessary as an insurance of adequate protection.

It is very difficult at this time to

state exactly what the Army and Navy would require in the way of radio material, owing to the rapidity with which the art is advancing. Suffice it to say that it is the duty of the military experts always to have their plans ready for complete standardization of equipment, and not only ready, but in such shape and detail that in event of hostilities the manufacturers could commence work on the morrow turning out standard equipment, in quantity and without delay.

The personnel engaged in this work in the Government is exceedingly limited and now that radio has grown into such a tremendous business it would appear that the most natural procedure for obtaining standardization would be by the radio commercial interests themselves, in consultation with the Government's experts.

The Army and Navy have been in the radio business for twenty-three years, and the advent of the public into this business, with limited exceptions, has been only in the last two years. A small number of civilian and military engineers have developed their art and have handed it over to the public on a silver platter, for the profit of the radio business man and for the

happiness of the public. Not only that, but the transfer of paramount control of transoceanic radio communication from foreign to private American control was directly due to our own Navy Department.

For these and other reasons there is a duty for the radio business man, particularly, to show some measure of gratitude to his military representatives in the way of assistance in keeping a step or two in advance of any possible adversaries.

In the history of the design and development of radio equipment it will be remembered that many of the principal advances have been due to the ever-increasing demands by the Naval Service for increased range, economy, selectivity, durability and flexibility of apparatus. For years there was very little attempt at improving the standard of commercial installations on shipboard, except where naval installations paved the way. Naval specifications have each year been made more and more rigid and the requirements more difficult to comply with. The result is that the inventors and designers produced something better from something not so good, and solved the problems which appeared impossible of solution.

Follow briefly a few developments, and note the advance and standardization of certain parts of Navy equipment:

The open or straight gap, to the rotary gap, with standardization of moving parts, interchangeable for 1, 2, and 5-KW sets.

The rotary to the quenched gap, with standardization of gaps, plates and washers.

The standardization on 375 meters for naval work, later 600 meters, and later still the transfer of military work into a band of wavelengths clear of the 600-meter wavelength, in order that maritime commercial communication could enjoy it exclusively.

The standard Navy 500-cycle 2-KW, 5-KW and 10-KW spark sets of

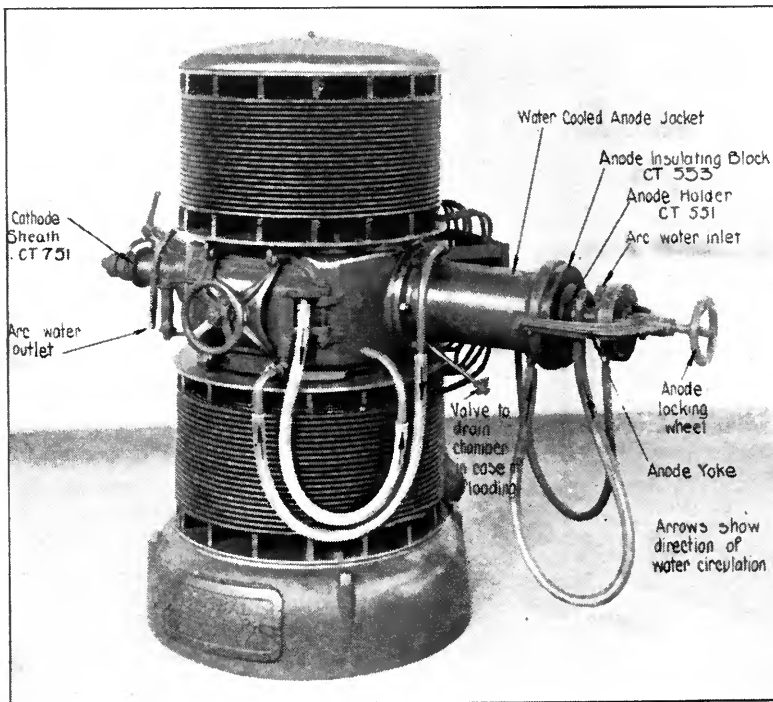

A 30-KW ARC CONVERTER

Its fittings are intended to be used equally well on the 20, 60, and 100-KW Converters

1914-17, which included standardized gaps, motor-generators, standard sizes of switchboard instruments, key contacts, fan motors, condensers, jar racks, and loading coils. The same sizes of condensers and gap units, for example, were applicable to all sizes of standard sets. Standard plans were prepared by the Navy and distributed to all manufacturers for use in bidding on these sets.

Standard $\frac{1}{2}$ -KW spark sets, adopted in 1917.

Standardized requirements as regards rating of 2, 20, 30, 100 and 350-KW arc sets, including certain interchangeable motor-generator parts, arc electrodes, electrode holders for arc sets, in 1915-16.

Standard form of operating procedure in 1915.

Standard sockets and standard electrical constants for receiving tubes in 1916.

Requirement for 2,000-hour life receiving tubes in 1916, raising the standard from 100 hours due to Naval insistence.

Standard mica condenser units and racks interchangeable in all sizes of sets were adopted in 1916.

Standardization on continuous waves for high-power communication, in 1915, although bitterly opposed by the Marconi Company.

Standardization on transmitting tube sizes, sockets and electrical constants in 1918-19, when these tubes were still in practically a research stage. The Navy invited the other interested departments of the Government, and the four tube manufacturing companies, to attend meetings in Washington for determination of standards in advance of development. This resulted in the adoption of standard sizes of 5, 50, 250, 750, and 3000-watt transmitting tubes and private companies immediately proceeded with developments of tubes to meet the requirements of these specifications. The filament voltage was standardized in each case.

Standard battery racks, and battery sizes were required, where practicable.

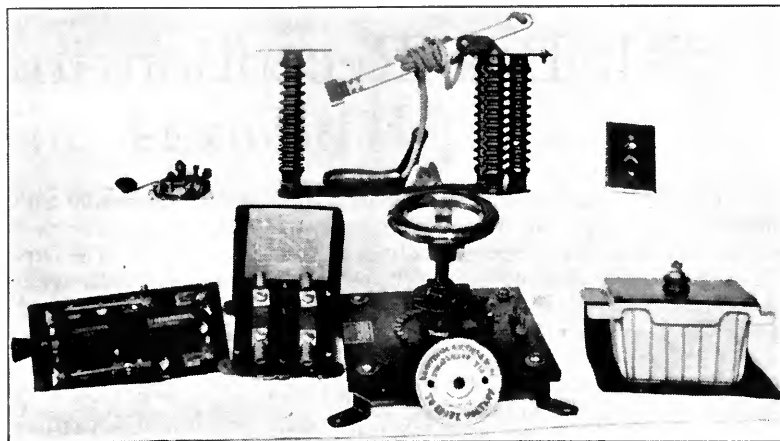

FOR USE WITH 1, 2, 5, AND 10-KW SETS

This group of interchangeable parts comprises a standard hand key, antenna switch, starter switch, control rheostat, condenser and transformer switch

Standard requirements of purchase and testing of installations and insulating material have been issued yearly for ten years, each year more rigid.

Standardization of aircraft radio specifications covering ratings of sets, aircraft antenna wire, fittings, fans for power supply, and other features requiring interchangeability, since 1918.

These are but a few examples of standardization that have been required as the art progressed and as foresight demanded.

The time has arrived to take stock again and to ascertain what standards are good, what standards are unsatisfactory, and what additional ones will be required to bring the art up to date. Where patent reasons stand in the way of standardization it is well to consider the desirability of making such concessions on the part of the patent owners, as may be necessary to the mutual advantage of the public, the manufacturer, and the military.

It is not necessary that the various manufacturers approve a standard in efficiency and appearance of equipment, or in improvements to aid in salesmanship, but it is highly desirable, that standardization be required as regards interchangeability of accessories and moving parts to a certain degree, and above all that a standard of quality be adopted so that the service will not be a laughing stock to the detriment of the trade and the interest of the nation.

Salt-Box Reception in Yoakum, Texas

This interesting letter, describing the experiences of one family with a home-made receiving set of the simplest type, needs only the plain statement of facts to show clearly how important a place radio holds among those who live in remote localities all over the country. The Orrs wound their coil on a salt-box and backed the family chariot up near the set when they needed a storage battery for their vacuum tube—and they tuned in Detroit, 1,230 miles to the northeast! There is no telling how far Billie and his mother and father will hear when the “chief electrician” gets one stage of amplification.—THE EDITOR.

Yoakum, Texas
Dec. 3, 1922.

RADIO BROADCAST,
Garden City, N. Y.
DEAR SIRs:

This is a composite letter written by a 13-year old boy, acting as chief electrician; his dad, some fifty years of age, as supervisor and reader of technical papers; and the silent partner, the mother (age not mentioned), enthusiastic listener and giver of hard-saved nickels when needed. I mention these details to show how radio can and does grip people of all ages.

We live in a small town, and last spring we caught the fever, so after much reading and talking, we built a set, consisting of a variometer and condenser. Alack and alas, nothing doing but a little of the now familiar rat-ta-ta. What was wrong? After much study and thought, it was decided the lack of sufficient inductance was responsible. We made a tapped coil on the old standby—a cardboard salt box—hooked it up, and presto, we had it! How good that music sounded, and when we heard the announcer say, “Our next selection—Mr. Watkins on the pipe organ,” we felt like throwing our hats in the air. Now, after months of experimenting and learning, we often think of our first thrill on getting this music out of the air.

How far do we hear? Bless your heart, we hear all over. We have heard Detroit, 1230 miles, Louisville, 930 miles, Atlanta, 840 miles, Davenport, 960 miles, Denver, 870 miles (our limits so far), and numberless stations between. St. Louis, Kansas City, Fort Worth, and Dallas are as familiar to us as the girl in our local phone exchange. We have also heard other stations, which we do not count, as in fairness to ourselves and friends, no stations are listed unless we hear the call letters, the name of the city, and at least two numbers on the programme.

What do we hear on? A tuning coil consisting of a cardboard salt box wound with some discarded No. 22 wire, tapped every ten turns for ten taps and every two turns for ten taps, a variometer in the plate circuit, a .001 condenser variable in the aerial, one tube and accessories. This set has been copied by several friends and it works. The aerial consists of a single wire, about ninety feet long (counting lead-in), strung up between two 2 x 4 x 20's on the roof, height above ground about forty feet. The aerial and guys consist of discarded telegraph wire, the total cost of the aerial, guy wire and masts being sixty-four cents. The filament current is supplied by our old automobile, which we drive close to the set, which we maintain in the shop where dad makes his living. Part of our success, we believe to be due to the fact that all joints are tightly soldered, all connections made of bare, hard-drawn copper wire No. 14, and all leads to the coil covered with spaghetti. From experience, we can say that loose connections are responsible for half the troubles in a set.

Now, Mr. Editor, if this letter is worth printing in your magazine, do so, and as the chief electrician wants to add one stage of amplification to his set, and is running errands, etc., to buy the parts, and you feel disposed to give him a helping hand, he will be grateful to you. We mention this in view of the statement made on page 61 (insert) November RADIO BROADCAST.*

Cordially in radio
BILLIE ORR,
Dad and Ma

*This refers to the announcement of the “How Far Have You Heard?” Contest, in which it was stated: “We are anxious to learn of experiences in broadcast reception, believing that their publication may help others to obtain the best results from their outfits. . . . For letters published, a very liberal rate will be paid.” This will still hold good, even after the contest itself has ended.

Radio-Frequency Amplification From the Ground Up

With Some Simple Details for Applying It to Your Present Receiver With Little Difficulty, and a Series of Six Graduated Circuits

By ARTHUR H. LYNCH

MUCH of the trouble experienced by listeners-in is directly due to an exaggerated ambition for long distance. Many of them read descriptions of new forms of receivers for which great claims are made and they decide to have one—and have it immediately. As a rule, their knowledge of the set is confined to a few technical terms which they repeat in parrot-fashion to some harassed dealer who is just as much in the dark as they are. Not more than a few days ago, a youngster asked me to draw a diagram and tell him how to make a radio compass. In the course of the conversation that followed, he described his single-tube receiver, which had been assembled from units bought one at a time, after comparatively long periods of saving. He spoke of the purchase of his storage battery as a great event and prided himself on a pair of phones that cost eight dollars—and he wanted a radio compass, for he had read of the great work being done by the U. S. Navy at its compass stations. He had a notion that a

radio compass could be made in a few minutes by adding a loop or something to his outfit. He thought it would be a fine thing to carry around and locate stations that interfered with his receiving. He also had some very vague ideas about radio-frequency and super-regeneration and many other technical subjects of which he knew little more than the name, but he was anxious to try them all—at once.

And this lad is just like a great many others and they are not all youngsters. It is a mighty good thing for the person just being initiated into the vagaries of radio to be satisfied with a good single-tube, three-circuit, regenerative receiver until he has mastered it. It takes a lot of skill to get the best from a receiver of this type and vacuum-tube detectors themselves offer plenty of opportunity for experiment before the best working point is found. Two steps of audio-frequency amplification do not cause much additional difficulty and are helpful when you desire to use a loud-speaker. They add but little to the distance over which you can receive, however. Of course there are some

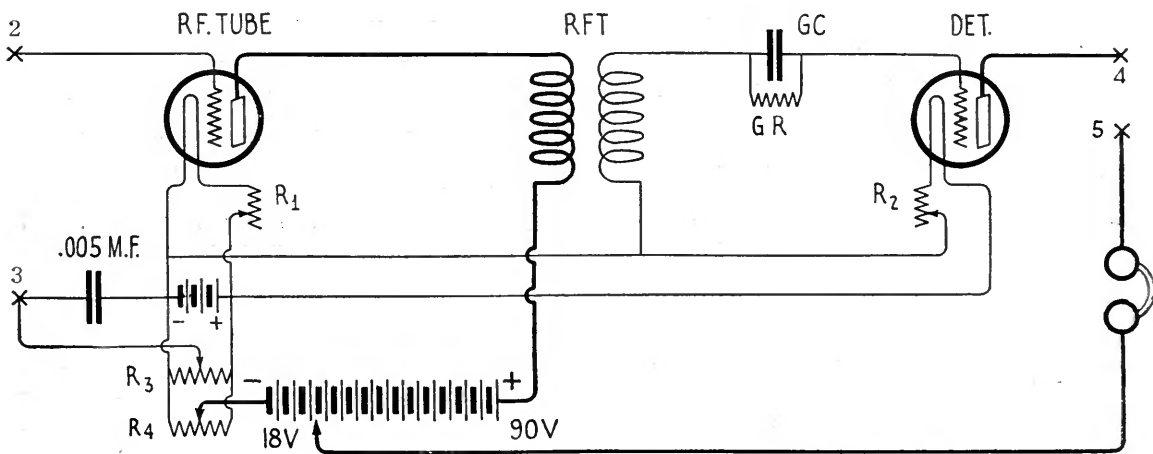

FIG. 1

A single-stage, transformer-coupled, radio-frequency amplifier and vacuum-tube detector applied to a standard coil mounting. Various adaptations of this arrangement are possible

receivers to be had which embody rather complicated circuits, but are made for operation by an unskilled person and some of them are good, although they are not cheap.

Before attempting radio-frequency or any other involved arrangement, it is best, therefore, that you master the operation of your detector tube, for much can be accomplished by proper filament adjustments at various plate voltages. A potentiometer is of great value. And regeneration is not the sort of thing that takes care of itself—it requires skill.

negative terminal of the B battery may be used to connect that terminal to the negative terminal of the A battery (Fig. 1).

THE PARTS NEEDED

- 1 Radio-frequency transformer.
 - 1 Vacuum tube (amplifier).
 - 1 Vacuum tube socket.
 - 1 Rheostat.
 - 1 potentiometer (200-ohm).
 - 1 fixed condenser (.005 mfd.)
- It is possible to do without the potentiometer

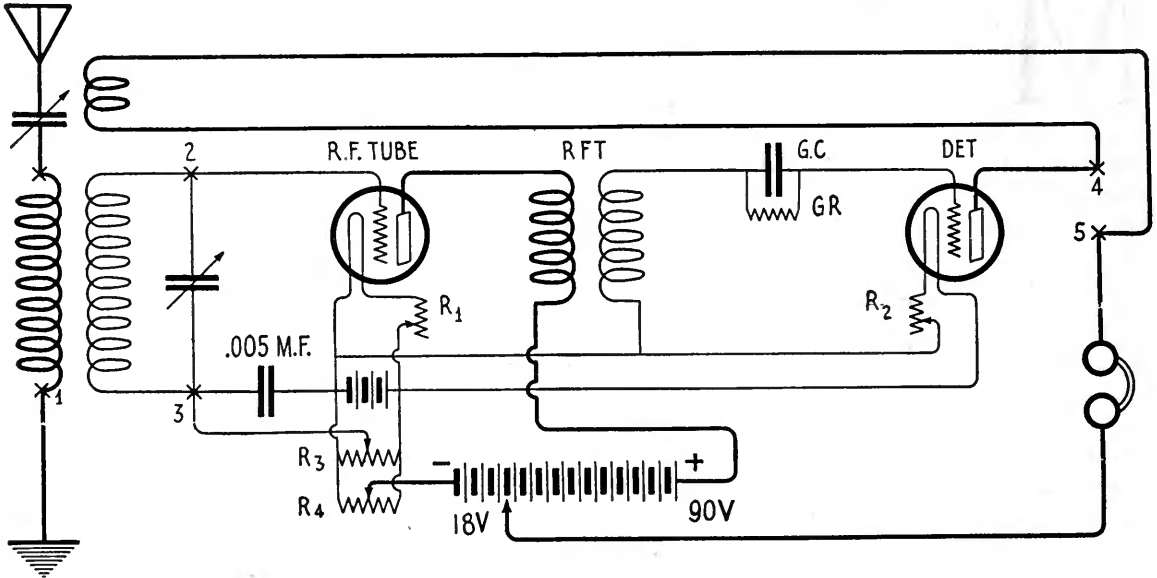

FIG. 2

By employing the proper spider-web or multi-layer coils and their customary condensers, Fig. 1 is made into a short-wave, regenerative receiver with one stage of radio-frequency amplification

One of the greatest advantages of the three-circuit receiver is found in the variable coupling between primary and secondary. Properly employed, it is helpful in cutting out stations that would otherwise interfere. Do you know how to use it properly? If you feel that you are getting the best possible results from your receiver and want to increase your receiving range or desire to use a loop antenna, the following pointers on radio frequency may help you to avoid some of the pitfalls.

There is no use in trying to use radio-frequency unless you are willing to go to the trouble of using it properly, and more than one stage is recommended for use only by those who have mastered a single stage satisfactorily.

We are taking it for granted that you are using a potentiometer in connection with your detector tube, but if this is not the case, the wire connecting the centre post of R₄ to the

and the fixed condenser but the results obtained are not as satisfactory.

A SIMPLE ARRANGEMENT

The circuit illustrated in Fig. 1 may be used in conjunction with any type of tuner and is comparatively easy to handle. It is a simple matter to add an audio-frequency amplifier or additional stages of radio frequency. By employing this arrangement with a standard multi-layer coil mounting, a number of variations are made possible with little loss of time.

The essential points in the circuit, at which the variations may be made, are represented (Fig. 2) by X¹, X², X³, X⁴, and X⁵, which correspond to the primary, secondary and tickler plugs of a standard coil mounting. X¹ and X² indicate the points between which the antenna tuning coil primary is plugged in. X² and X³ are

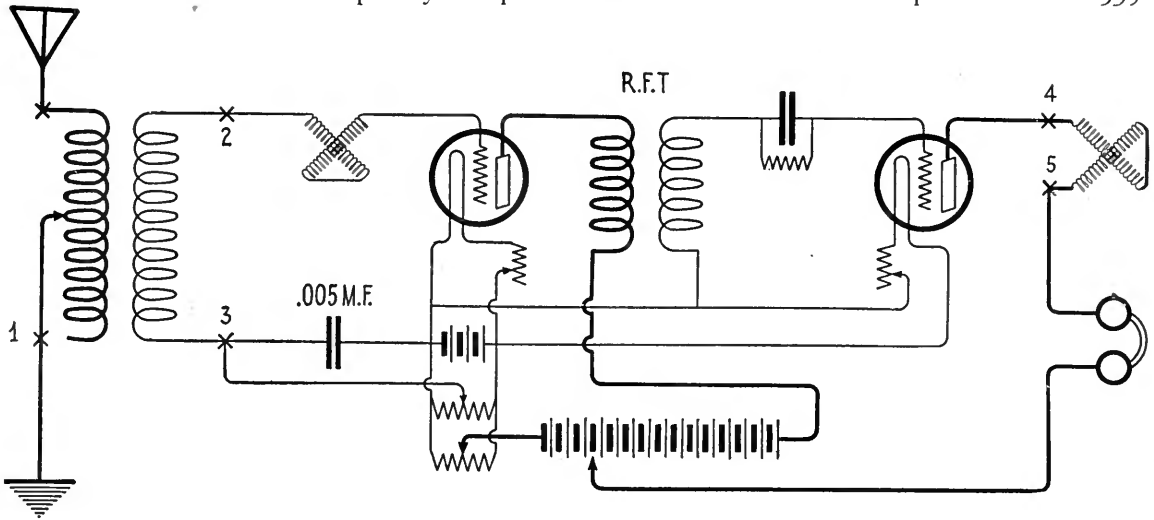

FIG. 3

A variocoupler and twin variometer regenerator and one stage radio-frequency amplifier may be made from Fig. 1 as shown here

the secondary terminals and the wiring to their right and to the left of X^4 and X^5 should be made in a permanent manner with "bus" wire if it is available.

Where a standard regenerative circuit is employed, the connections are made as in Fig. 2. In order to employ a variometer and twin variocoupler regenerator, the circuit in Fig. 3 is used.

Where a Tunit unit is used to convert a standard long-wave receiver into a short-wave outfit, the Tunit is merely plugged in, in place of the three multi-layer coils.

For those who would employ a loop antenna there are two methods available—the non-

regenerative and the regenerative. The difference is found in that portion of the circuit between X^4 and X^5 . Where regeneration is not desired, it is but necessary to connect a short piece of wire between these two points.

But regeneration is usually desirable, and is obtained by connecting a variometer between X^4 and X^5 .

The loop itself should be provided with two flexible leads, twisted together and attached to a plug which may be used in place of the secondary coil of the three-coil regenerator. When a loop antenna is employed, the regular antenna should be removed from the set and the primary coil should also be taken out.

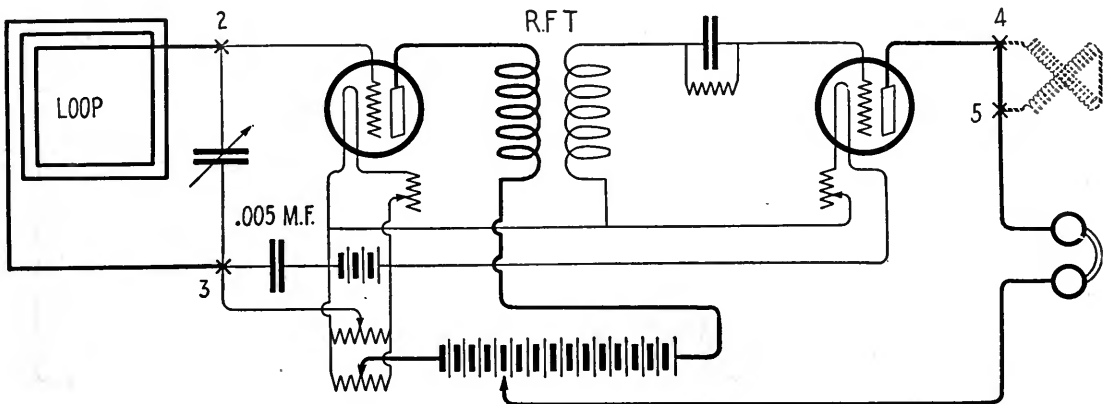

FIG. 4

For loop reception no primary is used. The loop is plugged in across the terminals X^2 and X^3 . If direct connection is made between X^4 and X^5 , as shown by the dotted line, the receiver will be non-regenerative. The usual variometer method of producing regeneration is indicated at the right by dotted lines

The condenser used to tune the loop may be mounted on the base of the loop itself or in the usual position on the panel, where it is used to tune the secondary when the outside antenna is employed.

You will notice that the grid of the amplifier tube is connected through the secondary or loop as the case may be, to the centre terminal of the potentiometer, R_3 . It is possible, by this arrangement, to impose a suitable voltage on the grid under the control of the potentiometer knob. A potentiometer used in this manner is frequently called a "stabilizer." Where more than one stage of radio frequency is employed, it is a good practice to have all the grids connected to this terminal as shown in Fig. 5.

The plate of the amplifier tube is supplied with 90 volts and none but a hard tube should be employed. The plate voltage of the detector tube is twice variable because a "B" battery with taps is used and a potentiometer, R_4 , is also in circuit.

Tuning of the various arrangements is apparent to those who understand the tuning of other circuits, so there is no need of discussing it here. For those who are not familiar with this form of tuning, it would be well to read "Regenerative Radio Reception" page 58, RADIO BROADCAST for November, and "Paris

and Honolulu Are Calling You," page 132, RADIO BROADCAST for December.

TUNED AND TRANSFORMER-COUPLED R. F.

WHERE a standard regenerator or a variocoupler and twin variometer outfit is to be fitted with radio frequency, it is possible to take advantage of two stages with a single R. F. transformer. In these instances, which are illustrated in Figs. 5 and 6, the tuning of the antenna circuit is accomplished by means of a coil, which may be a multi-layer or a tapped single-layer coil in series with a variable condenser, the antenna and ground. For loop reception, it is but necessary to connect the loop and its shunt condenser between the grid and negative battery lead of the first amplifier tube.

By the arrangement shown in these two figures, the primary of the tuner is shunted by a variable condenser (23- or 43-plate) and may be tuned to any wavelength within the limit of its inductance and capacity. The secondary circuit in Fig. 5 may be tuned by the condenser and in Fig. 6 by the variometer. Here we have two tuned circuits forming the primary and secondary of the second radio-frequency transformer—in other words, we have one step of transformer-coupled and one step of tuned radio-frequency amplification.

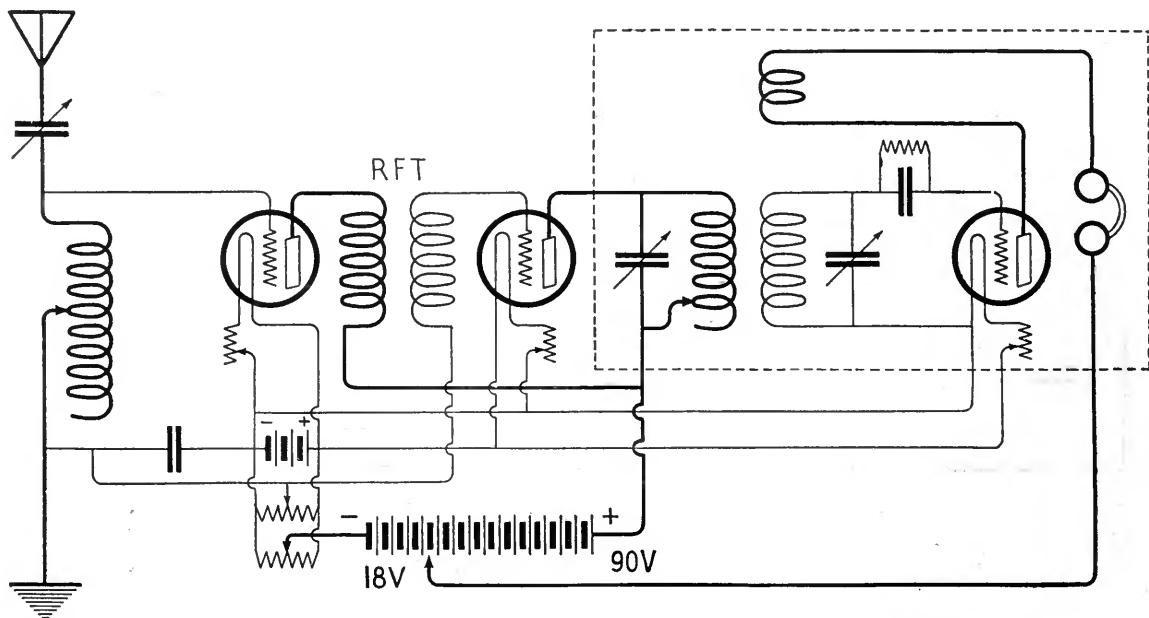

FIG. 5

A single radio-frequency transformer and two amplifier tubes may be applied to a three-circuit regenerative receiver (shown within the dotted lines) to provide one stage of transformer-coupled and one stage of tuned radio-frequency amplification

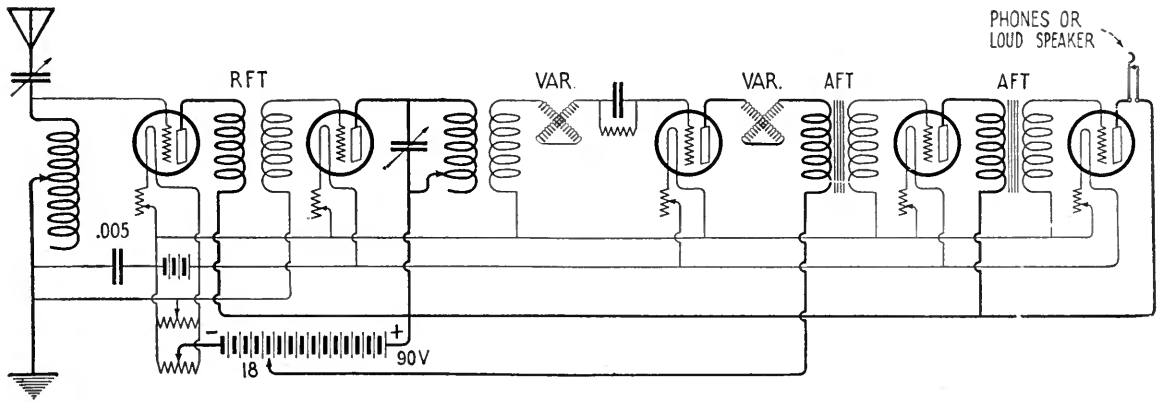

FIG. 6

In this five-tube circuit there are two stages of radio, a detector and two stages of audio-frequency amplification. A variocoupler and twin variometer, regenerative tuner is employed and the antenna circuit is tuned by a tapped coil and variable condenser. Long distance and loud signals are the reward for mastering the complex manipulation this outfit requires

These circuits are more difficult to operate than the single-stage, transformer-coupled variety we have considered, but there are many experimenters who will derive a great deal of pleasure from the two-stage arrangement. Some fellows revel in complexities—and more power to them!

Before signing off, we must point to the two stages of audio-frequency, illustrated in Fig. 6. They follow immediately after the detector assembly and no trouble should be experienced with applying them to any of the foregoing circuits. If you want to do yourself a favor, don't attempt too much at once, or, like the fellow who bites off too much, you won't be able to chew.

The following symbols are used in the figures and the capacities and values of in-

ductances are those used in operating below 600 meters. Very few of them perform very well at 200 meters. Most radio-frequency transformers are designed to function at greatest efficiency on the broadcasting waves of 360 and 400. Some very ambitious claims that do not hold water are made by certain of the manufacturers and it is well for you to procure your radio-frequency transformers from dealers who know and can be relied upon telling the truth concerning their wavelength range.

X, X¹, X², X³, X⁴, X⁵ indicate the standard multi-layer or spider-web coil mountings.

R₁ and R₂ are receiving filament rheostats.

R₃ and R₄ are 200-ohm potentiometers.

RFT indicates the R. F. transformer.

GC and R are the grid condenser and leak resistance; .005 is a .005 mfd. condenser.

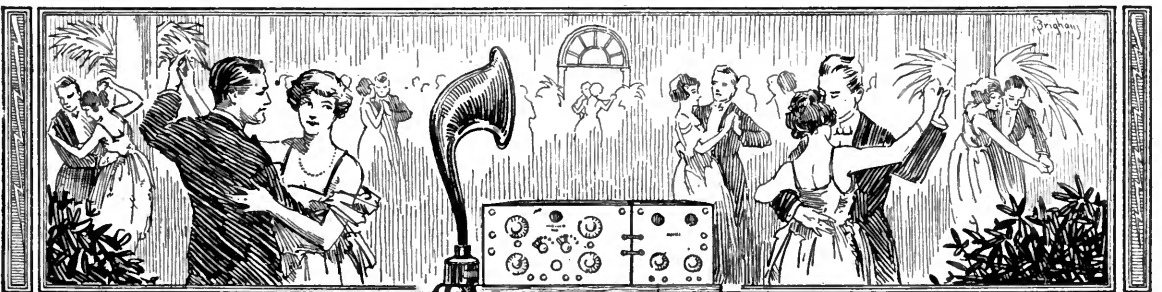

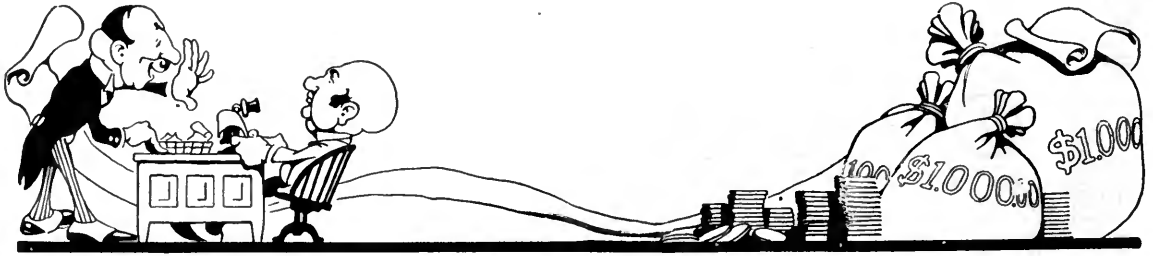

“Ride to Riches With Radio”

Some Get-Rich-Quick Schemes that are All Bull and a Yard Wide

By H. J. KENNER

Managing Secretary of The Better Business Bureau of New York

LAST summer the public was greeted by the lusty and hungry cries of newborn radio promotions in the latest infant industry of the United States. These companies had sprung up all over the country as a direct result of the sudden popularity of radio and the almost unlimited publicity gained by this fascinating product of many inventions.

The best known and most experienced radio engineers, who were plugging away at their scientific tasks, refused to get over-excited by the public furor, and were most reticent about the commercial possibilities in the manufacture of apparatus, but the professional promoters and stock manipulators, who cared nothing for the scientific development of radio and who were merely determined to make this new art and industry pay them a tribute, were not slow to tell the public what would happen. This gentry moved by the scores and hundreds into the radio field, organized companies and began campaigns for funds to launch their own corporations. In New York, they had started many companies, had done most of the work in preparation for their stock sales campaigns, and were already descending upon the public with small, select armies of hair-trigger salesmen and with advertising of the “do-it-now” ballyhoo type.

The Better Business Bureau of New York City undertook a survey of the radio field. It found the industry already infested with unsound financial organizations. If none of these companies had gathered in big sums of money from the public, it was because it had not had the time. In line with the policy of the Bureau

and the Truth-in-Advertising movement, it was determined to tell the public about the fake radio companies before they gained much headway.

Among the stock-selling radio companies the International Radio Corporation appeared to be the worst offender. It was capitalized for \$4,000,000 and the stock was being sold by various small brokers in and around New York. The company had a large suite of offices. It professed to be a going concern and boasted a plant in Newark. The company's officials and sales agents talked very optimistically of its immediate future, saying, among other things, that the “I.R.C.” had acquired several valuable patents, and that its officials were nationally known in finance and prominent in radio science. Immediately after the bulletin exposing the International Radio Corporation had been published, Charles Beadon, promoter of the “I.R.C.,” brought complaint against the managing secretary of the Better Business Bureau for criminal libel, and two civil libel suits asking damages of \$600,000 were filed against the managing secretary and the members of the board of directors of the Bureau.

The result of all this bluster was that the criminal libel case was thrown out of court and the other two suits were dropped. When the criminal libel suit came up for a hearing, Jerome Simmons, counsel for the Bureau, merely pleaded truth in defense of his client. Relying entirely on the testimony of former officials and employees of the “I.R.C.,” Mr. Simmons proved that every statement made in the Better Business Bureau's bulletin was true.

Thus, according to the “literature” of the

“I.R.C.,” it had acquired the assets of the P.W. P. Manufacturing Company of Newark, N. J., “which already had a nation-wide reputation for the wireless and radio apparatus it has manufactured for four years.” Bureau pointed out in its bulletin that the P. W. P. Manufacturing Company had been in existence in Newark only about a year, not four years, had very limited distribution and that it was not nationally known. In its sales circular, the “I. R. C.” stated that it had taken over the output of four factories in addition to its own. The Bureau’s bulletin stated that it had actually contracted with two small factories for their products, at prices which the consulting engineer of the “I. R. C.” admitted to be high. In order to impress prospective stockholders, salesmen of the “I. R. C.” claimed that the De Forest Company and Butler Brothers, the mail-order house, had placed with it big orders for radio parts, and that from forty to fifty persons were busy at work in the company’s Newark factory. The bulletin, dated August 18th, showed that all these claims were false, that the company was making no profit whatever, that the De Forest Company and Butler

Brothers had never placed any orders for radio sets and not more than twelve people, mechanical and clerical, were employed in the so-called Newark plant.

Another falsehood in the “I. R. C.” sales circulars gave an account of valuable patents owned and controlled by the corporation, especially the “Rich-Tone Loud Speaker Horn” invented by Mr. Francis Judd, who for a short time was employed by the International Radio Corporation. Salesmen claimed this instrument would revolutionize the loud speaker industry, both in price and quality. The Better Business Bureau bulletin said that these patents had not been granted, and the inventor himself, Mr. Judd, testified that only an application had been made for patents and that none had been granted. It was hardly necessary to refute a claim made by salesmen of International Radio Corporation stock that Mr. Judd’s horn *eliminated static!*

One of the chief stock-selling devices of the “I. R. C.” was a motor car equipped with a radio set which toured the streets of New York. The sales literature of the “I. R. C.” referred to the operator of this car and its radio set as

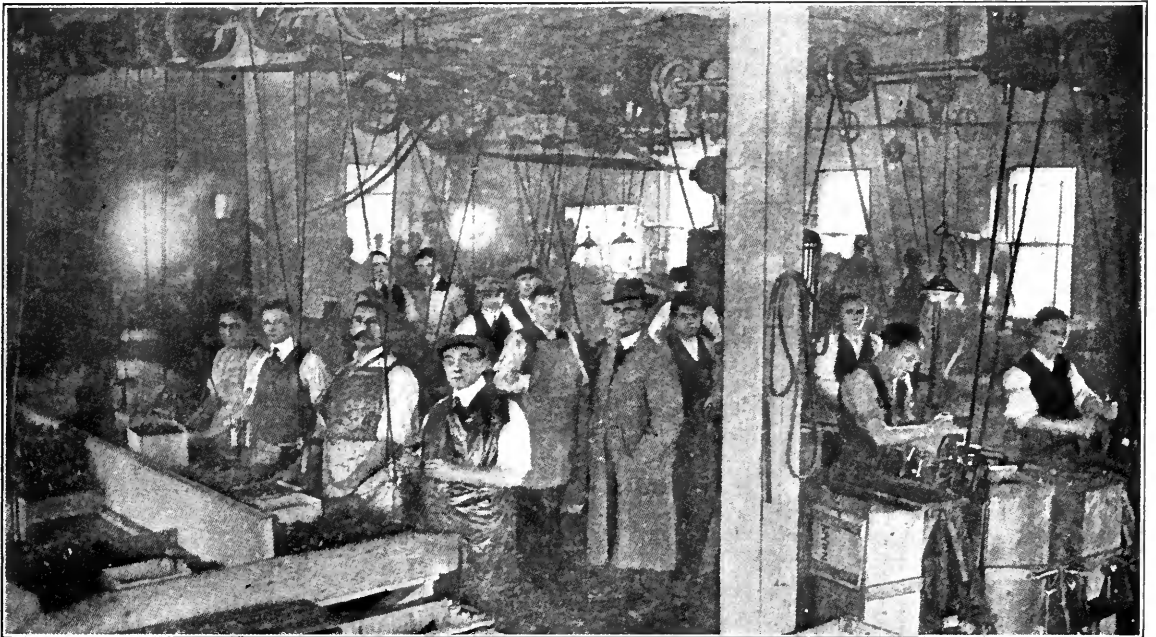

“SECTION OF MACHINERY AND TURNING ROOM. NEWARK PLANT, N. J.”

“An elaborate sales circular, which had been sent through the mails, contained several full-page pictures of the exteriors and interiors of factories located in various New Jersey towns. The sales circulars did not actually state that these pictures were taken of buildings owned or operated by the new radio company, but that was the inference that anyone would draw from hastily looking over the booklet. A brief investigation disclosed that the company owned nothing and that the pictures were of factories with which the company had entered into tentative agreement to supply it with various radio parts”

follows: "He makes the impossible possible, receives while in motion with the aid of its International Radio set and loud speaker."

At the hearing on the criminal libel complaint, a young electrician, who had originally equipped the motor car, testified that he had used a standard radio set and apparatus made by the Westinghouse and General Electric companies and that none of the apparatus which he put on the car had been manufactured by the "I. R. C."

The company had advertised that its financial adviser was:

"Internationally known to business men and has been the associate of such well-known magnates as J. P. Morgan, Cornelius N. Bliss, Gov. Benj. Strong, Jr., J. D. Rockefeller, Jr., and the late Henry P. Davison, Herbert Hoover, and a score of others." In various other ways, stock salesmen referred to this same man as "former financial adviser to J. P. Morgan & Company," or as "former member of the Advisory Committee of J. P. Morgan & Company." The subject of these laudatory remarks testified that he had never acted as the financial adviser of J. P. Morgan & Company. He resigned his position with the "I. R. C." as soon as he discovered that these misrepresentations were being made about him.

The truth of the assertion made by the bulletin that the "I. R. C.," had, without authority, used the name of a junior officer connected with one of the best known trust companies of New York City, as a director of the "I. R. C.," was likewise proven in court.

Another radio company, whose affairs were scrutinized by the Better Business Bureau, promised to mend its ways at once. This company had gone even further in misrepresentation than the "I. R. C.," but its activities had been very limited. The company had been organized by a few men who knew practically nothing about the radio field, except that radio sets had leaped to instant popularity and that prospects of the money-making possibilities in the industry appeared to be good. The company was prepared to market a \$5,000,000 stock issue, ostensibly for the purpose of manufacturing radio sets and parts. An elaborate sales circular, which had been sent through the mails, contained several full-page pictures of the exteriors and interiors of factories located

in various New Jersey towns. The sales circulars did not actually state that these pictures were taken of buildings owned or operated by the new radio company, but that was the inference that any one would draw from hastily looking over the booklet. A brief investigation disclosed that the company owned nothing and that the pictures were of factories with which the company had entered into tentative agreement to supply it with various radio parts. Within two or three months the company had three times changed its president and had twice changed its entire Board of Directors. The "moral pressure" effort of the Better Business Bureau led to the abandonment of stock-selling by this company.

Another company had stolen, almost word for word, the corporate name of a radio manufacturing company which was recently taken over by one of the largest corporations engaged in the manufacture of radio sets. All of these companies sketched, in their sales literature, the enormous profits made by various remarkably successful industrial enterprises, such as the telephone and telegraph industries, and indulged in various blue-sky speculations which led prospective stockholders to believe that radio might rival the telegraph and telephone in profits to investors in companies that manufactured apparatus. They failed to tell the public they had no "service" to sell, which is the source of profits of the long-established telephone and telegraph corporations.

There seems to be a widely prevalent belief that the salesmanship of wild-cat stocks are endowed with marvelous salesmanship ability. As a matter of fact, such stock salesmen, as a general rule, are men of very mediocre calibre. They do not depend on cleverness, but on effrontery and tricks that are almost childish. They know certain practices that are prevalent among men of their type. And one reason they succeed in selling their securities is that they are early in a new field, offering stock in companies in fields which have greatly aroused the public's curiosity and interest. Promoters of fake companies work on the theory that "where there is public interest, there also may be found public confidence," and salesmen of fake stock play their strongest card when they trade on the public's hopeful confidence in the success of enterprises in fascinating new fields of science and industry.



GOVERNOR CHANNING H. COX

Of Massachusetts, broadcasting from WGI, the American Radio and Research Corporation's station at Medford Hillside, Mass.

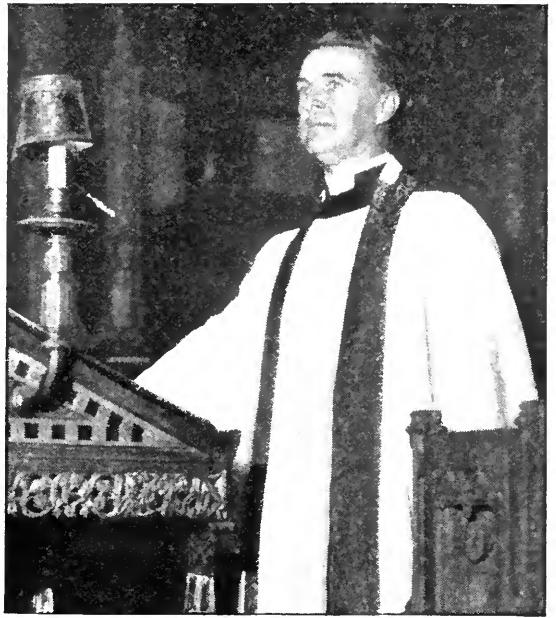

DR. ERNEST M. STIRES

Whose sermons have been transmitted by wire from St. Thomas's Church, New York, to WJZ, and from there sent out to a huge radio congregation



© Underwood & Underwood

TITTA RUFFO SINGING AT THE FIRST OF THE CONCERTS FROM THE BROOKLYN NAVY YARD (NAH)

Left to Right: Lt. Comdr. J. W. Reeves, Jr., U. S. N., Rear Admiral C. P. Plunkett, U. S. N., Titta Ruffo, Captain R. D. White, U. S. N., and Enid Grange

What About Operating as a Career?

Not Much Money But Opportunity Aplenty. A Chapter from the Diary of a Commercial Radio Man

By A. HENRY

FROM time immemorial there have always been those youths, who upon reaching eighteen years of age and a knowledge greater than that of all their forebears combined, find the section of the world they occupy small and stuffy. They feel the call of the wild, so to speak, and occasionally prevail upon parents, whom they consider a trifle behind the times, to permit them to leave school and get a "job".

I was one of them, and although I knew absolutely nothing about the sort of life I was heading for, an overwhelming desire to travel—to see the world—filled me.

At school, my record had not been bad, in fact my parents used to take some pride in it, but from the time the wanderlust siezed me I was a slave to it. In justice to myself, I must tell you that I did try to carry on for a while, but it was a forlorn hope. As I spent more and more of my spare time devouring books of travel, my marks ran lower and lower.

I knew it was an effort for my parents to keep me in school and that was a trump I held up my sleeve awaiting an opportunity to play it when it would be most effective. But it wasn't necessary. One Friday afternoon, school was let out early for the week-end in celebration of a victory for the debating team. I caught a train and entered the house without making any noise. My mother was in tears. I had never seen her cry before and it would be hard to describe my feelings. It seemed that

the trouble was a poor investment—some houses built, well but not too wisely

That was the last straw, and I cannot help remembering with mingled wonder and amusement at the eloquence with which I told the ruler of the roost that the morrow would find

me employed—making money, not spending it. It is a rather strange truth that at six, a boy thinks there's no one in the world so great as his father; that at eighteen, he believes his father a "back-number," a "has-been"; and that at thirty, he begins to realize that the "Governor" was not such a dull star, at that.

The next day found me in the job all right. It was not too far from the holidays for the department stores to require additional help and

I had no trouble in locating as an "inspector" in one of the largest and best stores in our city. When I learned I was to attend the store's school for a few days before entering upon my inspecting duties, I felt that I had the world by the forelock and actually wondered how I had managed to talk the grandiose gentleman, who allowed me a few minutes of his time, into making an inspector of me at the very outset. Nor was my joy entirely toppled over when I learned that my salary was to be five dollars a week. I had asked for ten, but a fellow shouldn't be too grasping, especially when he has never been employed before.

To cover this period briefly I may tell you that I was an inspector in the book department. The duties of an inspector were to inspect the

Perhaps You, Too, Would Like to Travel

It may be that you are a father of a restless son, or an ambitious son of a "father of the old school." Be that as it may, you may want to choose a career for yourself or help some young man to choose one. Radio operating offers a great reward for the youth who can use his wits. The pay is not great, but there are many ways of increasing one's earnings.

This is the second of a series of true stories about the life of a radio man written by men who have been through the mill. The first was "Choosing a Radio School," by Howard S. Pyle, published in the October number. In this article, and those which are to follow, Mr. Henry pictures life at sea as it really is—without the dolling-up usually found in the radio school advertisements.—THE EDITOR.

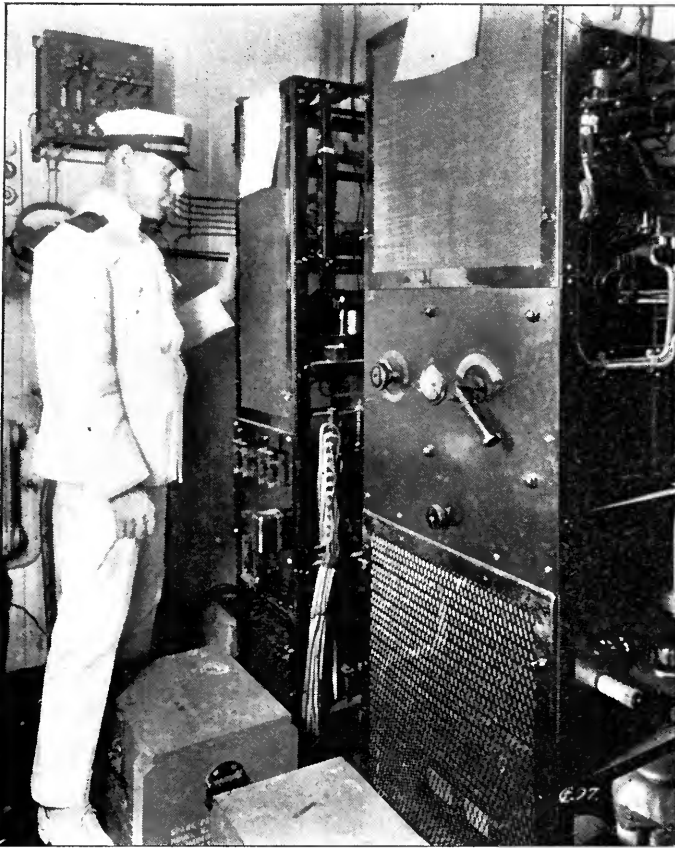

COMPLICATED MACHINERY AND A MAN IN WHITE UNIFORM
Are the average layman's idea of the radio man's job. It may be so, if you have been in the game long enough or are particularly fortunate. As a rule, however—

sales slips and the articles that accompanied them, to see that they corresponded, and then *wrap them up*. "Inspector" proved a polite term for "wrapper." At the end of two weeks I found that, after carfare and lunch had been paid for, I saved one dollar and forty cents per week. And the approach of the Christmas season made it necessary for me to work until nine o'clock at night, without extra compensation. I rebelled and was "fired."

My second job was "stock boy" in the jewelry department of another large department store, at a salary of seven dollars a week, with an additional fifty cents for "supper money" for evenings we had to work. By this time I had çajoled myself into the firm belief that I was truly a "comer," and my belief in my ability to brow-beat the world was aided and abetted by the stories of young men who had accomplished great things, appearing from time to time in the magazines.

I had affected long trousers but was not permitted to wear socks and suffered some embarrassment at the hands of the boys who delighted in pulling my trouser legs above my knees to display and laugh at the long stockings thus brought into view.

And I never lost the ambition to travel, though it was squelched occasionally by the pressure of events.

After the holiday rush, I expected summary dismissal with the arrival of each pay day, but my forebodings were unjustified and I was beginning to feel more and more like a business man. By catching a train before the "Governor's," I could sit in the smoker and enjoy my morning pipe and paper, just like the other men of affairs. And with the abating of the duties I was called upon to perform, came the wanderlust again with renewed vigor. From the Geographic Magazine and the pamphlets of steamship companies and railroads, I began to learn of Bombay and Callao, Honolulu and the Fiji Islands. Each had its own distinctive appeal.



—THE RADIO MAN IS HIS OWN LAUNDRY
And he finds that salt water and salt water soap, even when mixed with plenty of elbow grease, do not make things very white

I had no money and knew my parents would not hear of financing a trip to the many places I wanted to see, even if they could afford it. For some time past I had been a radio enthusiast and had, by diligent practice upon an old automobile horn, connected to a half dozen dry cells and a key, acquired a slight knowledge of the Morse code. Continental, the code used for radio now, was not in vogue then, and the neighbors were treated to my practice until late at night—every night, even Sunday, for the "Governor" sang in church and the Sabbath was duly desecrated during his absence.

A friend informed me of a radio school run by the Marconi Company for instructing young men, with a view to placing them on its vessels when they became proficient. I persuaded the family to let me go to the school. I do not dilate upon this for the reason that it was a very difficult task and I nearly lost out. The folks wouldn't hear of my going away—they hadn't been informed of my ambition to travel and the ice had to be broken carefully. The man in charge of the radio school looked me over rather critically and said, "Too young! Come back in about a year!"

But I haunted the school and refused to take his decision as final and he softened to the

to remain at the school it was necessary for me to carry home stories of jobs at the "land stations." I spoke of them as though land stations were the only places where they employed operators. In two days I was talking motor-generators and spark-gaps and tuning-coils and carborundum detectors as glibly as though radio had been my special study for many years.

After ten days' schooling, I was called into the holy of holies presided over by the superintendent, who told me he was going to assign me to a sea-going tug owned by the Standard Oil Company. The assignment was accepted in all seriousness, just as though I expected to be allowed to fill it.

The valuable slip of paper was not displayed at home until the evening meal had been long completed and the three girls were in bed and asleep—I knew loud talking would wake them. So we held a council of war and I was chairman of the council. In the course of my week at school I had learned that the land stations to which I had called attention so frequently could only be secured after a rather indefinite period at sea—sort of a sea-going novitiate.

"Where's the steamer going and how long is it to be away?" was my father's question.

I had not informed him that the steamer was a tug, so my remarks had to be framed with great care, for I firmly believed that there would be no trip for me if the whole truth of the case were known. Most of my remarks dealt with the fact that I was to be the *Chief Operator* and I discreetly refrained from mentioning that in addition to being chief, I was to be the *only* one. The superintendent had told me that my room was a spacious one right beside the Captain's. That was very fine ammunition to feed the folks.

By the time sailing day arrived, nearly everything was ready and my bags were duly packed. I pass

over the "good-bye" scene, for it was just like any other, where the young hopeful leaves everything near and dear to him to go out and conquer the world. There was a single exception. My father accompanied me to the "vessel." I will never cease being grateful to him for having done so.

I found that the *Astral*—that's the name of the good ship—was coaling at Communipaw,



MY OUTFIT AT HOME

Gave me a great deal of practice and made it possible for me to get through the school in a short time

extent of allowing me to take an examination. He must have been satisfied with the result, for I was admitted to the school. I went home in a burst of glory that evening to spread the glad tidings. I waited until we were well launched in the evening meal before breaking the news.

No one enjoyed that supper very much, for there was a mixture of tears and speeches I cannot and would not care to recall. In order

New Jersey, and was going to pull out about midnight. So we took the train from our home on Long Island at about six, and ferried to Jersey. I don't remember just what happened then.

You see, it was February and it was cold and it was dark and we had to trudge along railroad tracks without end. Neither of us had ever seen the *Astral* before, and all vessels looked more or less alike in the haze caused by escaping steam intermingled with flickering and sputtering arc-lights. Dad was straining his eyes for a liner and I kept a sharp look-out for a tug.

After walking a very long distance we came upon two men and I saw a battle raging in my mind's eye, as they approached. As soon as they were within a reasonable distance, the "Governor" hailed them and the blood nearly froze in my veins.

"Do you happen to know where the steamer *Astral* is coaling?" he asked.

After a moment of consultation one of the pair said, "If you mean that Standard Oil tug, she's right ahead of you—about a quarter of a mile. Think that's her name. Watch your step, there's a break in the rails about half-way up."

During the remainder of the walk, neither of us had anything to say, and after having visited three other boats, we found the *Astral*.

Coal buckets were flying hither and yon and it was a hard job for us land-lubbers to get up the single, narrow plank used as a gangway. Surely this was no time to give the vessel a looking over, so we repaired to the Radio Room under the guidance of a raw-boned, genial-looking brute, who told us in battered English that he was a fireman.

My room was all the "Super" had said it was—and a lot more. It was located on the main deck just about 'midships and extended all the way from the port to the starboard side. I did not know which was which but did know one was right and the other left, so there was little chance of a *faux pas* in the presence of the begrimed sea-going fireman. There was a wooden door and a port-hole on each side and there were half-inch steel storm doors used to protect the wooden ones in bad weather.

On the after side of the room, recessed in the bulkhead (that means wall) were spaces for four bunks, but only one was made up, and a nice, clean looking bunk it was. Directly opposite the bunk was the radio outfit. It would have delighted the heart of any radio



THE GOOD TUG "ASTRAL"

I had not informed my dad that the steamer was a tug. Most of my remarks had dealt with the fact that I was to be *Chief Operator*. I had discreetly refrained from mentioning that I was to be the *only* operator

man. It was an outfit of the sort that was standard in those days and I could not suppress the desire to operate it.

At that time, the New York *Herald* operated a station in New York City and sent press items to ships at sea at regular intervals. The operator was on that night. I copied the press and for the first time the "Governor" seemed to think that there was really something to "this radio thing" after all, and I felt like a conquering hero—that is, I guess conquering heroes must feel as I did that night.

Then Dad went home and left me to my own devices.

I unpacked my three bags. It's a good thing none of the real sea-goers happened in on the performance, for it might have amused them greatly and been embarrassing for me. It might have been difficult for them to appreciate the need for the two bottles of spring water I had with me to prevent getting typhoid from the water kept in dirty tanks for weeks on shipboard. Cans of potted beef, cocoa, evaporated milk and many other delicacies were to be found aplenty, for no one would ever expect to find such things at sea—unless, of course, he had been to sea.

Be that as it may, here I was in a position

of respect, which would carry me to parts unknown and ports unseen. Here, indeed, was opportunity to see the world and to be paid for the trouble. My salary at that time was thirty dollars a month, or as one

of the "mates" put it, when we had moved four miles after bucking a head wind for nearly two days, "What do we care, Sparks? The more days, the more dollars—a million days, a million dollars!"

Mr. Henry has promised us some very interesting incidents for the articles to appear in the series he is preparing for RADIO BROADCAST.

He will tell how, on his first trip, he spent four hours calling S O S—when shipwrecked only a few miles from a lighthouse and a radio station—before his call was answered. His experiences as a salesman of vacuum cleaners and phonographs in foreign lands are humorous and instructive.

The story of his visit to England, in 1914, just after Germany declared war, and his three-day respite in a Liverpool jail for taking movies of the famous "Black Watch" as it paraded up Lord Street, Liverpool, will be enjoyed especially by those who visited England with the A. E. F.—THE EDITOR.

Becoming Familiar with Great Music

By MABEL TRAVIS WOOD

THE average American is none too familiar with the great in music. He may know that Donizetti is not an Italian breakfast dish, but could he whistle the second movement of "Danse Macabre" at a moment's notice, or give the title and the composer of "that operatic thing that's played so much"? How many radio fans, hearing a well-known musical classic wafted into their living room without an introductory announcement, could quickly recall just what it is?

Radio can help train your music memory, as well as your musical appreciation. Seattle's music memory is batting high on account of a recent Music Memory Contest in which radio played an important part. The contest was arranged by Seattle Community Service and a local newspaper, following the plan which has been promoted in many cities by the National

Bureau for the Advancement of Music and by Community Service.

For three weeks the city was familiarized with twenty-four selections of the world's greatest music through newspapers, schools, churches, music stores—and radio. At the end of that time neighborhoods gathered at the various schools, listened to phonograph snatches of the selections and wrote down the names of the compositions and of their composers. Young and old competed, and two hundred and fifty dollars in prizes was awarded to the neighborhoods having the highest scores.

Every night during the contest one of the selections was broadcasted, together with a short description of the music and biographical sketch of the composer. Radio enthusiasts in all parts of western Washington could listen to such treats as the sextet from "Lucia" and Cadman's "Land of the Sky-Blue Water."

To Acknowledge an Error

Through an error, we stated in our November number, page 36, and in our December number, page 123, that Mr. Philip R. Coursey was editor of *The Wireless World & Radio Review*, London. We have been advised that such is not the case, but that he is a member of the editorial staff of this organ. Mr. Hugh S. Pocock is the editor, and we take this opportunity to express our regret at the mistake

Famous Radio Patents

By CHARLES H. KESLER

Member of Bar of District of Columbia, and of New York Patent Law Association

WHILE several courts have decided that the Fleming patent covers the audion when used as a detector, such courts are divided on the question of infringement when the audion is used as an amplifier and as a generator of oscillations.

Beginning in 1912, Armstrong, De Forest, Hogan, Langmuir, Meissner, Vreeland, Waterman, Weagant, and others, while using the audion as a detector, independently observed that it could oscillate or generate oscillations. These observations and investigations have resulted in numerous inventions involving the oscillating tube circuit and amplification, the most noteworthy of which is the Armstrong circuit. With the impetus given to the use of

tubes by these investigations, it is but natural that the question should arise as to whether such improved circuits infringed the Fleming patent.

A tube when oscillating is acting in a reverse manner. Instead of putting an oscillating current into the tube to get a rectified or direct pulsating current, a rectified current is imposed on the tube and an oscillating current is obtained. The action is analogous to that of an electric motor which, while producing motion, when current is passed through it, will produce a current when its armature is mechanically rotated. Neither Fleming nor De Forest contemplated this use of their tubes at the dates of their inventions.

The district federal court in New York has decided that the Fleming patent covers the

Hazeltine Chart No. 4 Simple Audion Circuit and Oscillation

GRID POTENTIAL

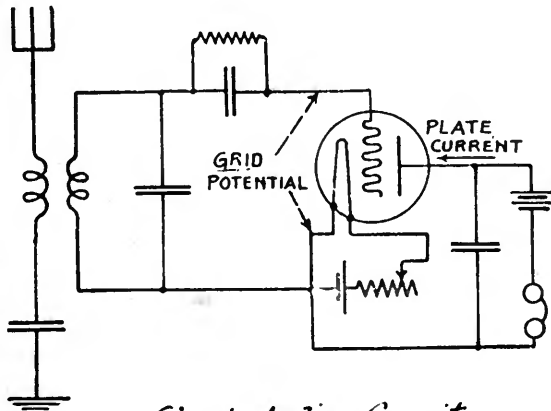

Simple Audion Circuit
(de Forest Catalog C, page 30,
with "Audion" Connection)

(a)

PLATE CURRENT

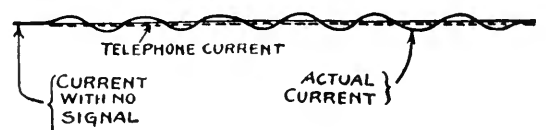

ZERO LINE OF CURRENT

Oscillation Not built up by Regeneration
(b)

FIG. 1

Circuit of De Forest grid patent, in use before Armstrong's invention

oscillating circuits (such as Armstrong's) and also the amplifying radio circuits. Although it was admitted that Fleming, at the date of his invention, had no knowledge of the use of his radio tube as an oscillator, yet the court was convinced that the two-electrode Fleming tube would oscillate when used with a battery and condenser and decided that the audion when used as an oscillator infringed the patent, Fleming being entitled to cover all uses of his invention whether appreciated or not, especially when it is a reversible use.

In the Federal courts of Delaware and California, however, on motions for preliminary injunctions, the courts, while granting injunctions on the Fleming patent against the manufacture and sale of tubes as detectors, refused to grant such injunctions in so far as the tubes are made and sold as oscillators or amplifiers. In other words, the courts refused to decide the question definitely before all the facts were before them at final hearing or trial, a preliminary injunction being issued only in clear cases.

Appeals have been taken by the Radio Corporation from these interlocutory decrees. It will be some time before these courts will definitely decide the points in issue, if at all, since the Fleming patent has now expired. After all the facts are presented, the courts may decide that Fleming covered the audion as an oscillator or an amplifier or both, or may decide in favor of the defendants. In each case an appeal can be taken. All we can say at this time is that the Fleming patent covered the audion when used as a detector but, as no appellate court has passed on the other questions, we do not definitely know if the patent covered the audion when used as an oscillator or amplifier in radio.

Of course the two De Forest patents also cover the improved tube circuits such as Armstrong's. No one can use the Armstrong circuit without a license and, even if licensed under the Armstrong patent, the regenerative circuit cannot be used unless licensed tubes are used (a license being implied from the purchase of a tube from an authorized seller.)

The rights in the two De Forest patents are owned by the American Telephone and Telegraph Company, which may license others to make, use and sell the tubes and by the De Forest Company, which has limited and re-

stricted rights to make, use, and sell them. The Radio Corporation of America, prior to the expiration of the Fleming patent, was the sole licensed distributor of radio tubes under the Fleming and De Forest patents, such tubes being manufactured by the General Electric Company and the Westinghouse Company. The De Forest Company can now manufacture tubes under its patents, being no longer under injunction by reason of the basic or dominating Fleming Patent.

The American Telephone and Telegraph Company recently sued the Radio Audion Company and the De Forest Company for infringement of the De Forest patents in the District of Delaware, in which suit the validity of the De Forest patents was conceded. The defense was a certain "immunity contract" given the Radio Audion Company by the De Forest Company, the latter agreeing not to sue the former for infringement. On a motion for preliminary injunction, the court decided that



the De Forest Company could not grant such immunity to the Radio Audion Company, which in effect was a license (the De Forest Company having no right to grant licenses) and held the Radio Audion Company to be an infringer. It seems that an appeal has been taken by the defendants, a bond being given in place of the injunction, pending appeal. The De Forest Company was held to be a "contributory infringer" merely. If this decision is affirmed, as it probably will be, the Radio Corporation and the De Forest Company will be the only authorized sellers of tubes for amateur purposes.

We will now continue the story of the audion and tell what Armstrong did. Between 1908, when the De Forest grid patent issued, and 1912, very little was accomplished, so far as the court records show, in improving the audion and in understanding or studying its properties. It was little used commercially. About 1912, a young student by the name of Armstrong was making himself a nuisance to the professors at Columbia University because he was using the laboratory to determine data and constants of inductive and reactive devices. Professor Arendt told Professor Mason to "get Armstrong and his stuff out of the laboratory." In fact, because of his interest in radio, Armstrong came near "flunking"—as it is called among the flunkable.

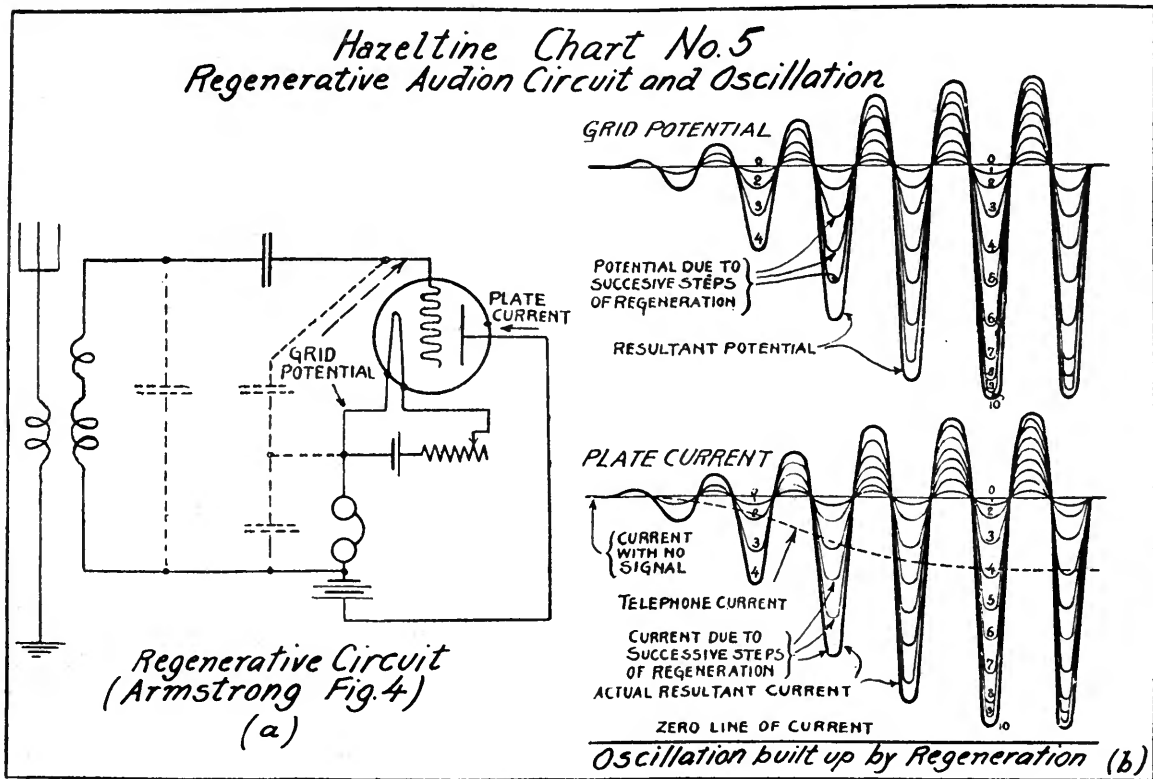

FIG. 2

Here, with the relocation of the telephones in the common portion of the input and output circuits, we have the "feed-back" circuit and regeneration. Compare with Fig. 1

This work of Armstrong at Columbia and at his home culminated in the invention of the now well-known regenerative or feed-back circuit, an instrumentality on which he was granted patent No. 1,113,149, which has been held to be valid and infringed, and to cover the regenerative circuit whether used as an amplifier or as a generator of oscillations and amplifier, either in receiving or transmitting. I have been informed that Armstrong has received for this patent and his recent patent covering super-regeneration, sums amounting to a million dollars.

The Armstrong Patent came before the court in the Southern District of New York in the case of Armstrong and Westinghouse Company vs. The De Forest Company. What the Armstrong invention is and what it is not was ably presented to the court by Prof. L. A. Hazeltine of Stevens Institute by means of two charts (Figs. 1 and 2). In chart 4 (Fig. 1) is shown a wiring diagram which was old or was in use before Armstrong's invention. In fact it is the circuit of the De Forest grid patent

which I described in RADIO BROADCAST for January. In chart 5 (Fig. 2) is shown an Armstrong circuit (Fig. 4 of his patent). It will be noticed, comparing the two circuits, that each comprises an input circuit including the grid and filament and an output circuit including the plate and filament. What is the essential difference in the two circuits? The difference is so slight that it may not be foolish to point it out: the relocation of the telephones in the common portion of the input and output circuits. But it was this slight change in the arrangement that made all the difference in the world. For, as the court found, we have here the feed-back circuit and regeneration.

Armstrong made a deep study of the audion and read everything which had been written on the subject. The invention was one, however, requiring experimentation—trying this and that—until the right arrangement was obtained and understood. In his investigations Armstrong made two important scientific observations, first, that the audion had an inherent capacity, acting like a condenser, and

secondly, that the radio-frequency oscillations, to an extent, were carried over into the output circuit and superimposed on the direct current produced by the battery in that circuit. As far as the record of the case definitely shows, Armstrong was the first so to crystallize or appreciate these ideas or facts as to attempt to utilize them practically by tangible means, an instrumentality, a circuit. Whether Armstrong first made these observations and then made the invention, or made the invention and then formulated the theory is immaterial. As the court found, there was an invention, while the observations made served to make the invention clear and understandable from a scientific standpoint.

Professor Pupin, the Columbia University electrical wizard, testified that all he knew about tubes he learned from his "pupil" Armstrong. At that time he thought the tube had no capacity, because of the conductive "space charges" therein. He was greatly astonished when Armstrong showed the fact to be otherwise. An inventor or patentee is not bound by any theory of operation of his device. It is enough if the device will work and can be intelligently adjusted to work. Armstrong's theory of operation of the audion and of regeneration is now generally accepted, however, as being correct (that is, of being consistent with all the facts as now known).

How Armstrong utilized the inherent capacity of the audion as a coupling to feed back the high-frequency oscillations in the output circuit to the input current, to reinforce the oscillations therein, is shown in Fig. 3 (which happens to be Fig. 3 of his patent). Comparing this figure with Fig. 1 (chart 4), the essential difference resides in the tuning inductance coil L' . The output or plate circuit is tuned to the frequency of the incoming oscillations. The circuit is otherwise the same except for the condenser C_4 shunting the battery to provide a free path for the electrical oscillations. The telephones in Fig. 3 are not located in the common path but may be, if so desired, to increase the coupling between the output and input circuits. The capacity coupling between the output and input circuit is very critical, as it was shown at the trial by an actual demonstration how, by merely moving the hand, the circuit could be put into and out of the "hissing" state, the oscillating state.

The invention covered by the patent was described by Prof. Hazeltine as follows:

The provision of an arrangement for transferring oscillating current energy from the plate circuit to the grid circuit whereby oscillations present in the grid circuit are assisted. Any arrangement by which oscillating current energy is transferred from the output or plate circuit of the audion to the input or grid circuit to sustain the oscillations in the grid circuit is included in the principle of the Armstrong invention.

The "arrangement" referred to, shown in chart 5, is the telephones, including the telephone leads, forming a capacity coupling, as indicated in broken lines in the figure. The "arrangement" of Fig. 3 is the audion acting as a capacity coupling and functioning as such by reason of the coil L' .

After having found out what regeneration is (if it be sufficiently clear) we can now compare the results obtained and action of such a circuit with those of the simple audion circuit, as represented graphically in charts 5 and 4. In chart 4, at the right (marked b), the upper curve represents the variations in grid potential and the lower curve the corresponding variations in plate current. These variations are caused by the incoming signal and are weak, and the dip in the average plate current is likewise weak.

In chart 5 (above b) we find curves marked 1 identical with the curves on chart 4, representing the grid potential and plate current for the first half cycle. During the next half cycle energy is transferred to the grid circuit by the feed back due to the variation of the plate current. This low plate current causes a building up of potential in the plate circuit, which is transferred to the grid circuit, reinforcing the low oscillation to give a greater oscillation 2, 3, 4, etc., that is, a higher variation in the grid potential, which in turn causes a higher variation of the plate current 2-3-4, the effect being cumulative, the variation being built up by increments applied successively, but even then substantially instantaneously.

The curves shown in chart 4 and 5 do not represent the magnitude of the energy in the circuits, but only grid potential and plate current, the energy varying as the square of the plate potential or of the plate current. For example, if the plate current in chart 5 has



a variation twenty times as great as the current variation of chart 4, then the energy in the oscillation which determines the intensity of the signal will be 400 times as great in the chart 5, which could not be illustrated for lack of space.

Another characteristic of the Armstrong circuit is that the potential of the plate varies inversely as the potential on the grid. That is, when the potential of the grid decreases the potential on the plate increases and vice versa. This is not true of the circuit of chart 4. Hence in the Armstrong circuit, as the plate potential increases, energy will be forced into the grid circuit.

While it was clearly proved what the regenerative circuit is and how it operated, yet at the trial the question arose as to whether or not Armstrong was the first inventor of the circuit.

And another question arose as to whether or not the patent in suit covered a regenerative circuit in an oscillating condition. The defendants attempted to show that De Forest was the inventor of the regenerative circuit prior to Armstrong, and especially of a regenerative oscillating circuit. Many sketches were introduced into evidence and much testimony was taken to prove this point, but to no avail, especially since it was shown that De Forest filed some twenty applications between 1912 and 1915, none of which showed or disclosed regeneration, and it was not until 1915 that De Forest filed such an application, which was after Armstrong's filing date, Oct. 29, 1913, and after Armstrong's publication in the *Electrical World*, December 12, 1914. This publication is now accepted as the last word on the subject and should be read by those sufficiently interested.

On March 16, 1914, a German by the name of Meissner filed in the United States patent office an application disclosing the regenerative circuit. The oath recited a German application filed April 9, 1913, which, under treaty arrangements, was the effective date of filing of the United States application. In other words, Meissner had a filing date over six months prior to Armstrong.

Under the patent laws of the United States, a patentee may show that he made the invention prior to his filing date. This Armstrong did, by introducing in evidence sketches, apparatus and testimony showing what the device was and when used or invented. Armstrong

testified that he had constructed and used apparatus embodying the invention in the fall of 1912, which apparatus was before the court at the trial. During the winter of 1912-13, he demonstrated the invention to several, but did not disclose the construction and arrangements of circuits. But these witnesses observed that the apparatus when adjusted gradually produced increased signal until a point was reached when the apparatus started to "hiss," a characteristic of the regenerative circuit.

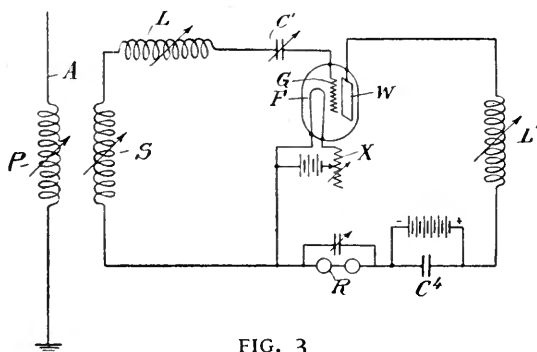

FIG. 3
The essential difference between this and Fig. 2 is in the tuning inductance coil, L'

It was not, however, until January 31, 1913, that Armstrong made a disclosure of the circuit arrangement to anyone. On that date he took a sketch of the apparatus and had it witnessed before a notary. His squadmate, Burgi, went with him and saw the sketch, but in testifying was not decided as to whether he understood the circuit or not. This sketch is identical with Fig. 2 of the patent (Fig. 4). However, it was not plain sailing for Armstrong at the trial, for not only had the notary died meanwhile but it was shown that the notary's recorded signature did not agree with the signature on the sketch. Testimony had to be taken to show that the signature was genuine and that the notary sometimes signed his name differently. In view of all the facts, the court decided that January 31, 1913, was the date of Armstrong's invention, thus beating Meissner by two and a half months.

It was a close call for Armstrong, not because he disclosed his invention to others, but because he didn't do it as fully and timely as he should have done. Although he was successful, he was successful only after going to a lot of trouble and expense to prove his point of early invention.

It is a misconception that a large number of inventors have, that they should keep their in-

ventions secret, at least until the application has been filed. How do they expect to prove priority of invention, either in a patent office interference or in a suit without witnesses, without something tangible such as a sketch or apparatus which can be authenticated by others? When an invention is conceived, make a sketch of it and have it signed and dated by several witnesses. Be sure that they understand the invention. But a mere sketch is not an invention. The sketch must be reduced to practice, as it is called; the invention must be reduced to practice. One way of reducing an invention to practice is to make the device or assemble the circuit, and also to make it work or perform the function for which it is intended. This does not mean a "model" but a full-sized actual practical thing that will work. Then have Bill Smith and Henry Jones see the thing and understand what it is. Let them see it work and point out to them the results obtained.

To strengthen still further the chain of evidence, sit down and write out everything that was done at the demonstration and make a sketch of what was seen and have everyone sign and date it. Now an invention has been made which can be proved, and if the invention as made checks up with the original sketch, the "date" of the invention is the date of the original sketch; provided diligence is exercised in the reduction to practice, the application can then be filed at leisure, but preferably as soon as possible.

In some cases, owing to a lack of capital, the inventor is unable to reduce his invention to practice. In such cases the application should be filed as soon as possible, the filing of the application being considered a "constructive reduction to practice." But a constructive reduction to practice is rather sketchy under a recent decision, in which it was held that the filing of an application cannot be considered a constructive reduction to practice where the invention shown and described in the application cannot, in fact, be constructed to make a practical operative device. So it is better to actually try the thing out before filing an application, so that the details of the invention can be covered and one can feel assured that what is shown and described in the application is operative.

In an interference proceeding in the patent office, the question of who was the first inventor among several applicants, or between an ap-

plicant and patentee, is decided. Testimony is taken just as in a law suit. The application of the Armstrong patent in suit, for instance, was in interference in the patent office with an application of Langmuir of the General Electric Company, in which interference Armstrong won out.

There is pending in the patent office at the present time an interference between pending applications of Armstrong, De Forest, Meissner and Langmuir involving the question as to who is the first inventor of the regenerative oscillating circuit, Armstrong having filed an application which he considers an improvement over the invention of the patent in suit, which covers regeneration or the feed-back circuit for all purposes. In this interference, priority of invention was awarded to Meissner by the examiner of interferences, on the ground that Armstrong had not proved a date of invention earlier than the filing date of Meissner in Ger-

many; the examiner taking the diametrically opposite view to the courts on substantially the same state of facts. The examiner believed that Armstrong lacked corroboration and that the sketch, as a sufficient disclosure of the date of invention, was not proven. It is understood that the examiners-in-chief have reversed the lower tribunal and awarded priority to Armstrong. It may be several years before a final decision is reached, as a defeated party can now appeal to the commissioner and from the commissioner to the Court of Appeals of the District of Columbia. In case the defeated party does not like the decision of the Court of Appeals, an action can be filed in any district court of the United States in which the commissioner is willing to appear to compel an issuance of a patent covering the invention in issue. Even though Armstrong may win out in the long run, it will be seen how important it is to fully disclose the invention as early as possible and to have available witnesses, drawings and apparatus to prove the invention and earliest date, especially in case of an interference and also in litigation. At least, large expense can be saved.

In summary, the Armstrong patent has been held valid in the second circuit and covers not only the feed-back circuit, when used as a receiver for amplifying, but also when used either as a receiver to produce beats by causing local oscillations, or as a transmitter to produce electrical oscillations.



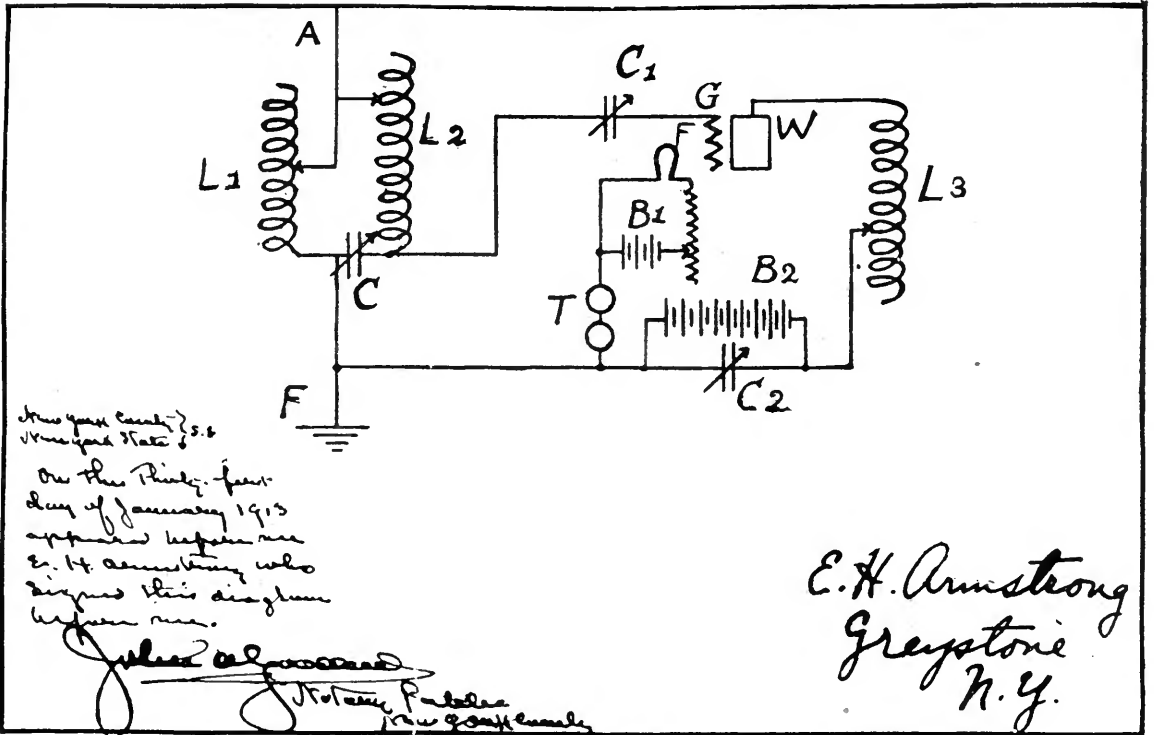

FIG. 4

The original drawing of the feed-back circuit which largely determined the court in Armstrong's favor

Whether Armstrong will secure a patent covering more specifically the feed-back as an oscillator depends on the outcome of the present interference. With the court decision to back him up he is in a very good position, I should say. While the court has been very liberal with Armstrong, and given the patent a very broad interpretation, yet it had no occasion to pass on all types of apparatus in which the feed-back may be or can be present, either deliberately or intentionally or accidentally or incidentally. In radio-frequency amplification, for instance, it has been found difficult by those who have no desire to infringe the Armstrong patent to prevent regeneration by reason of the inherent capacity of the tube, such regeneration being more detrimental to clear reception than advantageous.

Although Armstrong lays no claim to cover audio amplification by the cascade arrangement,

I understand he claims to cover certain arrangements of radio amplification, where it is necessary to have circuits tuned to the high frequencies, and especially when there are adjustments capable of varying the amount of regeneration.

It must be admitted that the endeavors of engineers to avoid patents have always resulted in important contributions to the development of the art, yet it is also an advantage to know where we stand and it is hoped (without wishing anyone any hard luck) that the courts can soon pass upon the scope of the Armstrong patent as applied to radio-frequency amplification.

While the Westinghouse Company is the owner of the Armstrong patent, fifteen or more other manufacturers are licensed under it and these as a rule advertise this fact and place a notice of the license on their sets. The patent expires in 1931.

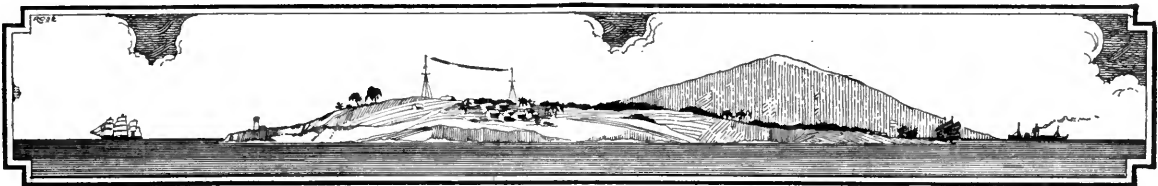

How Synthetic Insulation is Made and Used

By D. J. O'CONNOR, E. E.

DURING the past six or seven years a new type of insulating material has been rapidly taking the place formerly occupied by hard rubber or vulcanized fibre in all types of devices. This is a material whose important element is a resin, produced by condensing phenol in the presence of formaldehyde and other chemicals. This synthetic resin has been produced by several different processes and has been marketed under a number of different names, but in spite of some slight variation in its characteristics it may be said to be approximately identical in its effect when used for radio purposes.

The names under which these resins produced from phenol have been marketed are Redmanol, Bakelite and Condensite. For insulating purposes, in radio or general electric work, each of them is used in two forms—moulded and as a laminated product with a fibre base. The laminated form is most im-

portant in radio work, being used generally for panels, winding tubes, socket insulation and so on. It is known to the radio manufacturer, dealer and amateur as Formica, Bakelite-Dilecto, Condensite Celoron, etc.

The remarkable progress which this material has made in competition with hard rubber and other forms of insulation is due to the fact that the synthetic resins give it the highest dielectric strength and permit it to be cut, drilled, milled and tapped very easily with tools that are ordinarily used with metal. It is preferable, as an insulator, to hard rubber and can be worked much more rapidly. It lacks brittleness and will rarely chip or crack. It will survive a heavy fall without breaking.

Fibre is a satisfactory insulator as long as it is kept perfectly dry. Phenol insulation differs from fibre in that it has a considerably higher puncture voltage, and more important still, it will not absorb water and thereby become a conductor instead of an insulator. It possesses higher tensile strength and the ready working qualities of fibre. In other words, Formica and the other phenol insulating materials combine the high dielectric strength and waterproof qualities of hard rubber with the high tensile strength and good working qualities of fibre.

The phenol resin binder has other qualities that make it valuable. It is practically inert chemically. It is not affected by alkalis, is practically unaffected by acids, except sulphuric and one or two others, and is resistant to steam and to heat under 350 degrees or so.

While the synthetic phenol resins of which the various materials of this type are made, are substantially

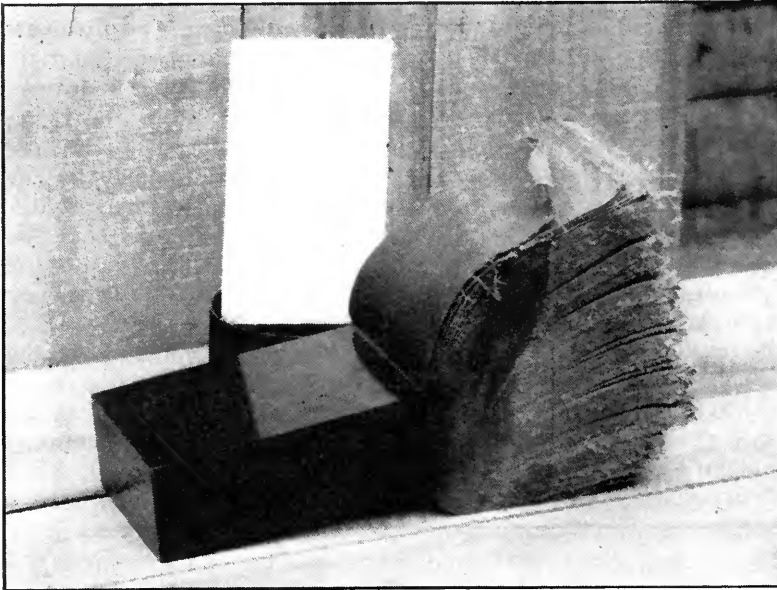

HALF OF THIS HAS BEEN IN A PRESS

And is finished Formica. The other half shows the many layers of fibre which make this material very tough, although it is easily cut and drilled. The synthetic resins give it a high dielectric strength

identical, there is still noticeable a considerable variation in the behavior of the finished products from this base. The phenol varnish is composed of two chemical elements which react upon each other; and at various stages in this reaction the characteristics of the resin vary considerably. The behavior of the materials made from the resin is therefore determined by the exact stage in the reaction which has been reached when the material is used in making the laminated or moulded material. This is a question of accuracy in manufacture and is handled by the better makers in such a way that the resulting product is remarkably uniform both in its electrical and mechanical properties.

Then there is the greatest opportunity for divergence in the nature of the fibre base that is used for the panels or tubes. Each of the manufacturers usually makes several different grades of materials. Some products have very high percentages of resin to provide the greatest possible dielectric strength. Others, intended for mechanical uses, or for uses where electrical insulation is under considerable mechanical strain and wear, are made up of especially strong fibrous material with a smaller percentage of resin.

The commonest forms of fibre base are paper and cloth. Some of the makers have given a great deal of attention to developing exactly the right type of paper for their use. In radio panels and tubes this is commonly a high grade of cotton rag paper, although good wood pulp papers are used for some purposes. In other grades, the best quality of cotton duck may be used, or cotton fabric of finer thread than duck.

The fibrous material is carried in rolls on a treating machine. The sheet passes through a compartment filled with the resin which it absorbs, and it then passes through a drier.

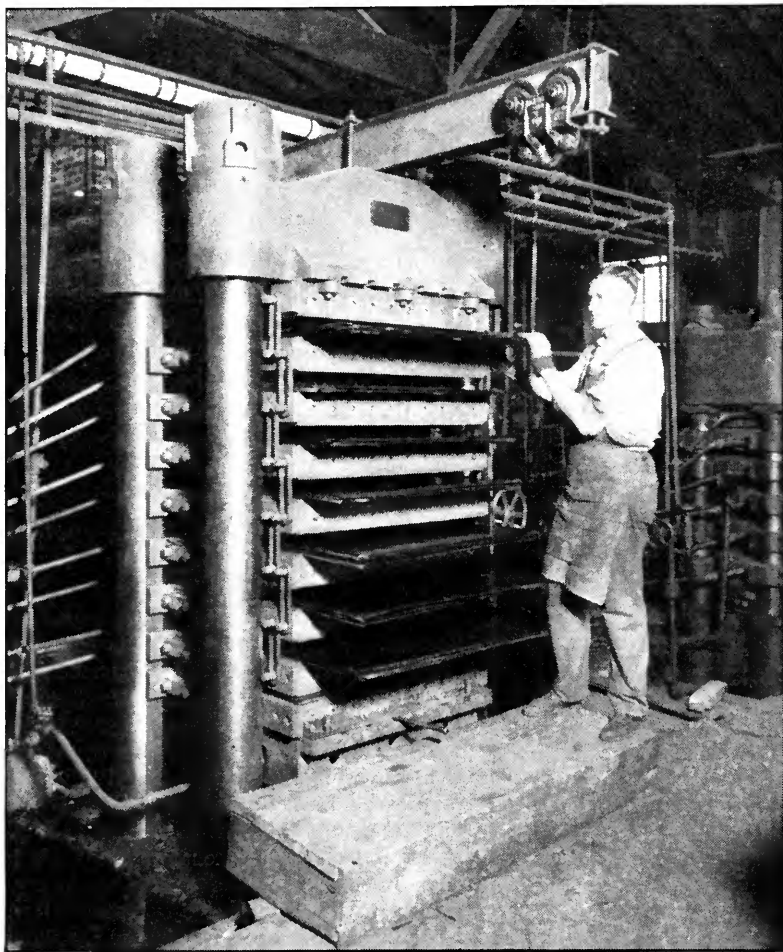

PRESSES IN WHICH LAMINATED INSULATION IS MADE

These sheets with the resin dried in them are then cut to the standard size and vulcanized under great heat and pressure into a solid sheet.

If tubes or rods are to be made, the impregnated fibre stock is wrapped on a mandrel, or simply rolled up tightly by special machinery. These round forms are then subjected to heat and pressure in the same way as the sheets. Some rods are also made by turning them out of sheet materials. The material takes a highly glossy finish, and it can be dyed different colors.

The moulded insulating parts made of Bakelite, Redmanol, or Condensite are similar in their electrical properties to the laminated material, but of course lack its high tensile strength, being more like hard rubber in a tendency to chip and crack, or break under a sharp blow, and do not machine as easily as the laminated material.

Simple Bulb Transmitters

PART V

By ZEH BOUCK

THE Colpitts system has been the fundamental circuit indicated in the radio-telephone and continuous-wave transmitters we have described as "power installations." The Colpitts circuit is probably the most efficient system when used with the average antenna, and seldom requires excessive experimentation to achieve success. However, in some cases, which are determined by certain inductive and capacitive antenna values, it is very critical and unstable in operation. If the experimenter, after following the instructions given for tuning and testing the set, is unable to secure at least three tenths of an ampere radiation on a single five-watt bulb, he is advised to alter the circuit to the British

aircraft system. This may be done by winding one additional coil, transferring the positive of the high potential to the upper side of the feedback condenser, and shifting the grid connection of the oscillating tube.

Figure 1 shows the fundamental British circuit, to which may be added any of the modulating systems previously described. For the sake of clarity in the drawing, an absorption loop has been indicated. The C and L values, excepting for the additional L₂, have been given in the December and January issues of RADIO BROADCAST. The auxiliary grid coil, L₂, is wound over the main antenna inductance, L₁, if the structure of the latter inductance permits it. In thus winding L₂, the inductances should be thoroughly insulated from each other by several layers of tape or empire cloth. If, however, L₁ is of the open winding or helix

type, the grid coil is best wound separately on a smaller tube, and placed inside of L₁, or otherwise in inductive relation to it. In either case, thirty turns of wire, tapped every other turn beginning at number ten, will suffice. As this is fundamentally a tickler circuit, it may be necessary to reverse the connections to L₂.

The final consideration in the category of low-power bulb transmitters, is apparatus which operates with alternating current on the plates. The power sets which have been heretofore described have been operated from a high-potential, direct-current source, supplied by some form of a motor-generator, or by rectifying stepped-up A. C. This last was accomplished by virtue of the unilateral (one way) conductivity of rectifying tubes and the chemical

rectifier, both processes being described in the February issue of RADIO BROADCAST.

Almost any circuit, such as the Colpitts or British aircraft, conventionally operated from a direct current plate supply, may be changed to a self-rectifying system, by merely substituting alternating current for the D. C. This of course alters the character of the emitted wave. The circuit now oscillates only one half the time (when the current is on that half on the alternation which charges the plate positively) with the result that the output is interrupted sixty times a second (assuming a sixty-cycle supply). Needless to say, it is impossible to smooth out this hundred per cent. modulating hum, and half-wave self-rectification can therefore not be used to transmit telephony.

The advantage of self-rectified C. W. sets is their economy, particularly with very high

How to Get Your Transmitting Licenses

If you wish to transmit, you must have two licenses, one certifying you as an operator, the other for your station. You must be able to receive at least ten words a minute (five letters or characters to the word), and must comply with certain other requirements explained in the Government pamphlet: "Radio Communication Laws of the United States." It is advisable to obtain this pamphlet, as it gives a list of places where examinations are held and other information either necessary or helpful to the prospective operator. It may be had from the Superintendent of Documents, Government Printing Office, Washington, D. C. Price, 15 cents a copy.

power sets, for the only primary power consideration, the transformer, is comparatively cheap. Thus a $\frac{1}{4}$ -K W. I.C.W. (interrupted continuous wave) transmitter is an economical possibility where a similarly powerful radio telephone, with rectifier or motor-generator equipment, would be from three to ten times as expensive.

A simple but efficient half-wave self-rectified set is shown diagrammatically in Figure 2. This set can be constructed for less than eighteen dollars, and was actually built by the author for \$16.70! The apparatus has a reliable range of twenty-five miles, and under very favorable conditions it can cover many times that distance. The transmitter uses a five-watt tube (or larger) with filament and plate potentials supplied from a single transformer built according to the general directions outlined in the two preceding articles. The transformer core is built up of 10" x 2" soft iron strips until it is two inches high. The primary is wound with 300 turns of No. 15 single cotton covered wire; the high-voltage secondary with 1700 turns of No. 27 double cotton covered; and the filament winding with 24 turns of No. 12 single cotton covered. It will be observed that none of the windings is "split," or tapped in the middle. The transformer is insulated throughout for 600 volts.

The antenna coil, L, is wound with 40 turns of any convenient insulated wire between No. 14 and No. 22, and is tapped every fourth turn. A 3- to 5-inch winding-form or tube may be used. C₁ is a fixed condenser of 3 to 8 plates of 1" x 3" tin-foil (two square inches active area) separated by mica. C₂, excepting that it uses only two or three plates, is similar to C₁. C₃ may be almost any capacity above .002 mfd., and is preferably the type of condenser shunted across sparkcoil vibrators.

R₁ is a 5000-ohm grid leak.

The following price list indicates the probable cost of the apparatus:

L	\$ 0.50
R ₁	1.10
R ₂	2.25
C ₁25
C ₂10
Transf.	3.50
Socket	1.00
Bulb	8.00

TOTAL \$16.70

In the preliminary tuning, a radiation am-

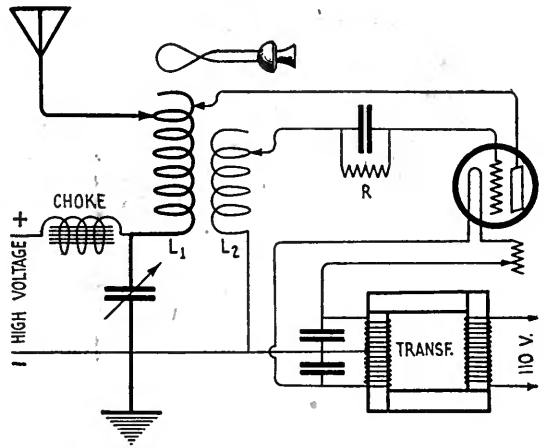

FIG. 1
The fundamental British circuit

meter should be included in the antenna circuit, and the lead from the condenser tapped to the eighth turn from the lower end of the inductance. The plate lead should be tapped to the upper end of the coil, and the antenna tap varied between the two.

A more desirable type of self-rectified set is that described theoretically last month as employing full-wave self-rectification—i.e., using two tubes, each operating on opposite halves of the cycle. Figure 3 shows a set of this type partially completed (mounted but unwired) which was designed and constructed by the operator of station 2ABP, New York City. The circuit is given in Figure 4.

The operation of the set is simple, and its self-rectifying action is evident at a glance. As the secondary current alternates, the positive and negative charges of terminals *a* and *b* undergo rapid reversals. When *a* is positive, the plate of tube *A* is supplied with the plus

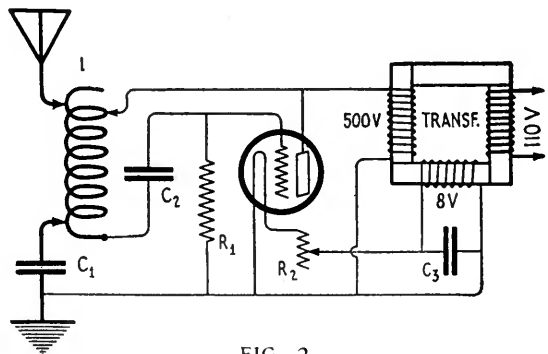

FIG. 2
Circuit of the half-wave self-rectified set which has been made for less than seventeen dollars and which has a reliable range of twenty-five miles

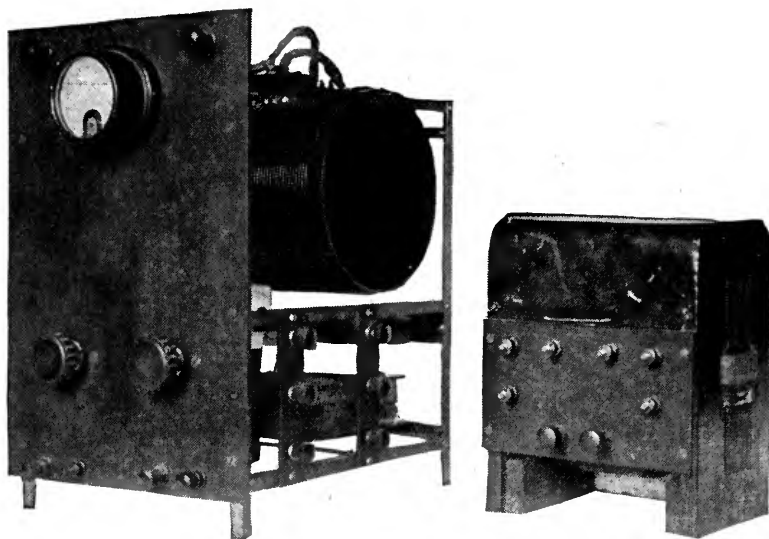

FIG. 3
Set employing full-wave self-rectification. The circuit is given in Fig. 4

potential essential to oscillations, while *B* draws no current and is quiescent. With the next half alternation the conditions are reversed, and the Plate of *B* is now positive. The centre tap is at all times negative in respect to the positive side of the high-voltage secondary.

Coil *L* is preferably of the copper ribbon design wherein the inductance is continuously variable. If the experimenter is unable to obtain a coil of this type, and the inductance is, instead, wound on a tube, it should be tapped at least every other turn. 40 to 60 turns of a 6-inch diameter are about right. *L*₂ and *L*₃ are radio-frequency choke-coils, which, though desirable, are not always essential, and may be *L*₂₀₀ honeycomb coils or their equivalent.

*C*₁, in a well balanced set, may be eliminated, and really lowers the over-all efficiency. However, it assists in tuning and compensates for the inadequate capacity of some antennas, having, on the whole, a stabilizing effect on the oscillations. If *C*₁ is used, it may be a receiving variable condenser immersed in oil. *C*₂ and *C*₃ are stopping condensers of approximately .002 mfd. each; but they are most conveniently built up in the form of a single condenser of .004 mfd. capacity with a centre tap. These condensers are conventionally of mica-foil construction, but the experimenter will probably find it more simple and economical to build it up with a glass plate non-conductor. Such a condenser may be made of six 8" by 10" photographic plates with 6" by 8" (active

area) sheets of tin or copper foil between them (Figure 5). *C*₄ and *C*₅ are by-pass condensers of the type already referred to as being shunted across spark-coil vibrators.

The transformer is identical with that described in the February RADIO BROADCAST for use with the experimental five-watt set.

Extensive experiments with this circuit have indicated that grid bias, either by condenser leak or "C" battery, is seldom necessary. However, when operation appears to require it, a grid condenser, shunted by a variable leak (5,000 to 20,000 ohms), may be

inserted in series with the grid lead.

As one of the two bulbs is always oscillating, excepting perhaps for the fraction of a second when the alternation is at zero, the output of this two-tube set is much more continuous than that of half-wave self-rectified circuits. By the inclusion of a large choke-coil (such as described as a filter reactance in the previous article) at *X*, the oscillations of the two bulbs may be made to overlap, thus further smoothing out the wave. Using an extremely large choke, or a multiplicity of smaller ones, this circuit has been successfully employed for telephony.

CONSTRUCTION

THE set is built up on an 8-inch by 15-inch panel, with a skeleton superstructure of angle brass forming the sides and back of a "box" twelve inches deep. These details are clearly shown in the photograph. Brass braces, conveniently placed, support the condenser, radio-frequency chokes, sockets and inductance. If the variable condenser is eliminated, the front of the panel is pleasingly simple, displaying only the rheostat control knobs and the radiation milli-ammeter.

Mr. Plumb (2ABP) has mounted the transformer in a very neat and original manner. Deviating slightly from transformer construction, as previously detailed by the writer, the two pies of the filament secondary have been wound on opposite legs of the transformer, the connection between the two being brought out

for the centre tap. (If the reader attempts this, he must experiment to determine which two leads of the filament secondary should be joined, so that a series rather than a bucking or nullifying effect will be had. To describe explicitly the winding direction and leads to be connected, would be confusing and tedious. The two pies or sections should be connected so that a fat, heavy spark is flashed by making and breaking the circuit with the two remaining leads.) End, or rather side blocks, are cut to fit snugly over the two core legs with filament secondary windings. The blocks are held permanently in place by the bakelite binding-post panel in the front, and by the sheet brass casing, which, when enameled, forms the whole into a neat unit.

CONCLUSION

THE operation of five-watt and larger sets demands an intelligent application of the theoretical knowledge acquired through experimentation with less powerful installations. Difficulties—many of them—will arise; but the experimenter should call in outside assistance only as a last resort. Indeed, he will benefit greatly by solving his own problems; and he should be able to do so, for the theory of the majority of difficulties he will encounter has been fully covered in this series. If the oscillating tube heats unduly—the plate becoming white hot—it is obviously drawing too high a plate current. To the amateur, the solution is flashed with the first indication of trouble. Assuming the filament and plate to be supplied at the proper voltage, the situation

is remedied by increasing the negative charge on the grid by decreasing the leak resistance. This solution will flash through the initiated mind, which reasons subconsciously that a negative grid will repel the electrons of which the plate current is composed, traveling from filament to plate. If, on the contrary, the plate current is low, with corresponding poor radiation, the process is reversed.

Dust, an accumulation of which may cause leakage, should be blown from between the plates of a variable feedback air condenser. A sudden labored grind of the motor-generator is indicative of a short-circuit, and this condenser will be first examined as the most vulnerable spot.

If the radiation drops during prolonged transmission, it may be due in part to the heating of the filament rheostats, which the experimenter will realize has dropped the E.M.F. across the tube. The filaments should be turned up slightly. However, it should be first determined that this is the case by a voltmeter reading taken directly across the filament. A tube, under all conditions, should be lighted from the proper *voltage* rather than draw the rated amperage. Operated in this manner, the life of a bulb will be often trebled over its comparatively short service when the filament *current* is kept constant. The filament disintegrates or burns out with a rapidity that is naturally proportional to the temperature at which it is burned. As the tube ages, the filament gradually becomes thinner, with a corresponding increase in resistance. The heat of the filament is directly proportional to i^2R

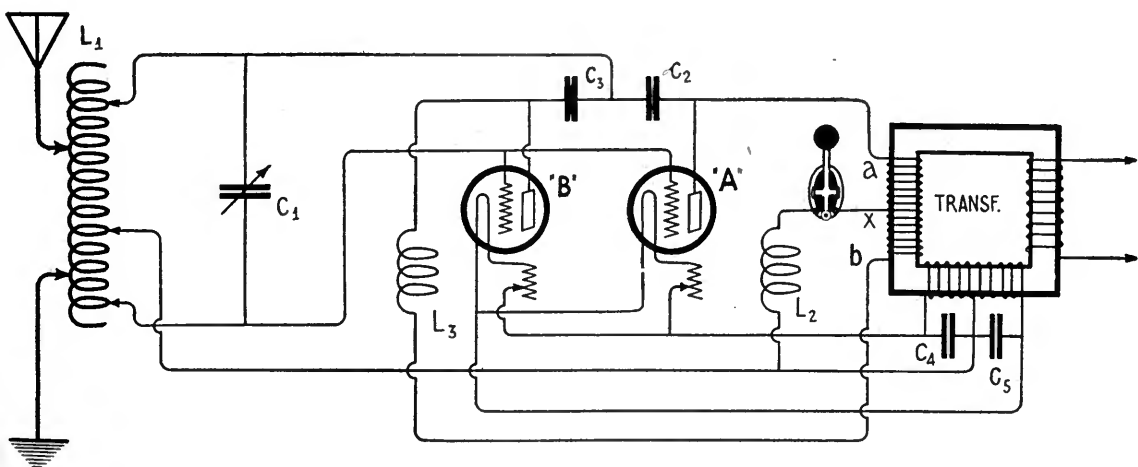

FIG. 4

A full-wave, self-rectified set, using two tubes, each operating on opposite halves of the cycle

(current squared times resistance). Hence, if the amperage or current is always kept constant (by gradually turning up the rheostats to overcome the increased resistance), the filament will be constantly burned at a temperature increasingly higher than normal, with a resulting rapid disintegration. On the other hand, if the voltage is kept constant, this will obviously not be the case.

For quiet and convenience, and to avoid possible induction, the motor-generator, filter and transformers should be located apart from the operating table—preferably in a closet, the generator slung from springs or resting on rubber cushions. The leads from the filament transformer must be of a very low resistance, necessitating No. 10 or even larger wire, to prevent an excessive fall in the voltage—a drop equal to IR , the current times resistance.

To transmit legally, it is necessary to secure

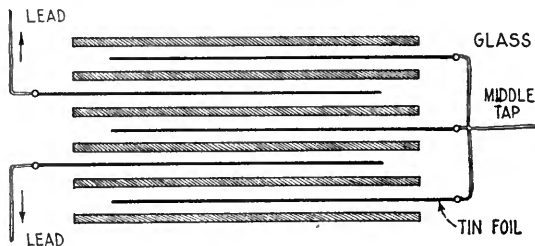

FIG. 5

Showing the construction of the stopping condensers (C_2 and C_3 in Fig. 4.) The glass plates are 8" x 10" and the sheets of tin or copper foil are 6" x 8"

two government licenses, a station license with the call letter assignment, and an operator's license qualifying the individual as a person capable of handling a station. Both licenses are generally issued simultaneously, following a successful examination for the operator's ticket. The applicant must receive and transmit ten words a minute, which, discounting nervousness and the sometimes erratic character of the copy, requires a general ability in excess of twelve words a minute. In preparation for the written examination, the student is advised to familiarize himself thoroughly with the following considerations:

How to tune his prospective station to two hundred meters; this question covering the theory and use of a wavemeter.

The more important stipulations of the

International Radio Telegraphic Convention of 1912, such as regulations concerning SOS signals, superfluous signals, interference, wavelengths, decrement, etc.

The International abbreviations ("Q" signals). The prospective operator should memorize and use whenever possible, QRT, QRX, QSA, QTA, QRS, QSZ, QRA and QSC. (See RADIO BROADCAST for May, 1922).

The theory of his contemplated transmitting and receiving set.

All inquiries regarding licenses should be addressed to the Radio Inspector in care of the nearest customs house.

However, the problem of transmitting is by no means solved by the Government's permission to send. The amateur fraternity, the backbone of citizen radio, has its own requirements and stipulations, which are far more exacting than those set forth by the Government. With the increase of transmitting stations, the air is rapidly acquiring more definite limits, and the amateurs are becoming less tolerant of those inexperienced ones who do not live up to their traditions.

The beginner should under no condition transmit until he is master of sending and receiving twenty words a minute! A clumsy, faltering, twelve-words-a-minute fist, or the long drawn out, inconsiderate telephonic speech of an operator whose few months in the game are perfectly mirrored in his poor code ability, will surely gain for the operator the permanent antagonism of the air.

The experimenter who can copy twenty words a minute generally has a solid year of experience behind him—experience that has taught him the desirability of two hundred meters, the methods of securing a sharp wave that will interfere with neither broadcast nor amateur listeners, the value of snappy concise operating, and the courtesy of the air.

The experimenter should join a progressive radio club, and become a member of some national amateur organization such as The American Radio Relay League. He should associate with amateurs, learn their language, their thoughts, their own abbreviations (which run into the hundreds)—in other words, becoming a psychological amateur before he is one in ability!

Best of luck, O M, and 73!

W J Y. Shenectoday

General store

sir

New York

states

i am gide for hunter man wat
come at dis place lac-des ilse for
hunting deer dese hunter man bring
it wit him machine for heer you
spik from far place i lissen wit
him sunday nite also tuesday nite
i heer song bout my ole modder
dats long tam i dont see my modder
an i ting dats dame fine song
also i heer oder song i dont no
de nam tuesday nite storie for
de small boy and gil bout mak
de star shine for dem if dey is good
boy and gil hunter man buff lak
hell an tole me ax you how we
make some moon shine
i heer you spik jus de same lak
your at me place i ting you have
good machine i lissen more
nex wick

tank you and much ablig

Gide Canille Poirier
Chemin P.O. Quebec Canada

A VOICE FROM THE WILDERNESS

This letter, purporting to be the original expression of a Canadian guide, was received by WGY, the General Electric Company's broadcasting station in Schenectady, N. Y.

Putting Through the White Bill

There Should be Little Delay in Reporting It Out of
Committee for Passage by the House of Representatives

BY JOHN V. L. HOGAN

Consulting Engineer, New York; Fellow and Past President, Institute of Radio Engineers;
Member, Institute of Electrical Engineers

THE new year of 1923 dawned auspiciously for radio. On January 2nd, the day before Congress reconvened after the holidays, the House of Representatives committee on the Merchant Marine and Fisheries opened hearings on the White bill. Notice that the public meeting was to be held had gone out only a few days before, but there were on hand representatives from the Telephone Company, the Radio Corporation, the American Railway Association, the American Radio Relay League, the Wireless Association of Pennsylvania, the National Radio Chamber of Commerce, and the government departments of War, Navy, Commerce, Agriculture, and the Post Office, in addition to a few others.

As you will doubtless recall, the White bill is directed toward amending the existing radio laws, and particularly the Act of August 13, 1912, to improve the governmental regulation of radio communication. As the law now stands, the Department of Commerce has little authority of a character that will permit control of such complicated interference situations as have arisen in ship-and-shore radio telegraphy and broadcast radio telephony. Secretary Hoover called a conference in Washington, last February, to study this matter of interference and to recommend steps for improving the conditions then existing. A report of this conference recommending amendment of the radio laws "to give to the Secretary of Commerce adequate legal authority for the effective control of the establishment of all radio transmitting stations except amateur, experimental and Government stations, and of the operation of non-governmental radio transmitting stations," was issued in March, 1922. Representative Wallace H. White, Jr., of Maine, prepared, and on June 8th, introduced into the House of Representatives, a bill resulting from the work of the Legal Committee of this Department of Commerce Conference on Interference. The bill was referred to the Merchant

Marine and Fisheries Committee, and has been lying in its hands pending disposal of the legislation on shipping.

Meantime, the broadcasting interference became worse and worse; new stations added to the babel, and with the coming of "long-distance weather" last fall, the need for fewer and better broadcasters grew evident to everyone. Even those radio users who had heard nothing of the proposed legislation said "the Department ought to do something about it"; the radio magazines began to ask what had happened to the White bill; and people commenced to write to their congressmen. As a result of all this, the projected law reached the public-hearing stage early in January and will probably have been passed by the House of Representatives (if not by the Senate also) by the time this report is published.

Secretary Hoover addressed the Congressional Committee on the afternoon of January 2nd, and in an interesting talk pointed out that the radio art was largely stifled by congestion of traffic on the comparatively few wavelengths available. As of December 27th, 1922, there were 21,065 licensed transmitting stations in the United States, of which the 16,898 amateur stations constituted by far the largest group. The next largest classification was that of ship stations, numbering 2,762; following that came the 569 broadcasting plants, only 25 of which were of the high grade type authorized to transmit on the 400-meter wavelength. There are, Mr. Hoover said, from one and one-half to two and one-half million radio receiving stations in use, and, necessarily, public interest in radio is profound. Nevertheless, the matter of interference (particularly in radio telephone broadcasting) threatens to undermine the useful purpose of the whole art.

The Secretary then explained that this bill had been drawn up by Mr. White to allow regulation of the causes of interference in so far as they could be reached by legislation, and that it was based upon the conclusions of the con-

ferences held last winter. One useful result of its passage would be the opening for commercial use of the formerly reserved military wavelength band of 600 to 1600 meters, and consequent relief of the crowding between 300 and 600 meters which causes so much of to-day's interference. Further, the Department of Commerce feels keenly its lack of authority in endeavoring, by means of the present laws, to reduce interference; thousands of interference complaints are received each month, and further regulation is desired by those working in the art. Mr. Hoover believed that the White bill had general approval.

The hearings lasted until late Wednesday morning, January 3rd. Every witness who appeared before the Committee endorsed the general provisions and the scope of the bill, though a number of amendments were offered to modify its applications in some details.

Rather than to abstract the suggestions of each of the interests represented, it will probably be more convenient to take up the topics that came under discussion.

The very first section of the bill states that the use or operation of "any apparatus for radio communication by telegraphy or telephony" or for the "transmission of radiograms or signals by telegraphy or telephony" shall require a Department of Commerce license. The American Telephone and Telegraph Company proposed that these clauses be made to indicate clearly that they referred to radio telegraphy and radio telephony, and this seemed to meet the views of the committee. Nevertheless, the possibility of radio interference arising from radio control or picture-transmitting systems, and from "wired wireless" or carrier current signaling over wires, was discussed at some length and it is probable that in redrafting the bill for reporting to the House of Representatives, the definitions will be broadened to give the Secretary of Commerce some control over certain of these other interference producers.

In the second paragraph of Section 1, the Secretary of Commerce is called upon to "make . . . regulations applicable to all licensed stations . . . concerning . . . the kinds of instruments or apparatus in any station with respect to the external effects produced thereby." This provision brought up the question of regulating interference produced

by oscillating regenerative receivers, a matter that had much attention from the earlier conference. Mr. White stated that the present bill was not intended to give the Department of Commerce power to regulate interference-producing receivers, although it was perhaps possible to define them as transmitters. Such definition would, it appeared, require them to be licensed and would subject them to complete regulation. Mr. White said further that the conference of February had thought the problem of controlling these receivers to be so great

that it had better not be taken up; enforcement of a law against their use might be even more difficult than enforcement of the Volstead act. Nevertheless, those present at the hearings seemed to feel that some authority should be given to the Secretary of Commerce that would permit him to minimize this "sending receiver" type of interference

if the art's progress did not automatically take care of the situation within a reasonable time. It was brought out that by using the new Donle "intensifier" tube or the regenerator with a non-oscillating radio-frequency repeater in the aerial circuit, the possibility of such interference was eliminated and yet nothing in sensitiveness was sacrificed.

THE NAVY'S "COMMERCIAL" STATUS

THE next point that came up for criticism was the proposal to have the Department of Commerce regulate (as to wavelength, decrement, etc.) such governmental stations as might handle commercial radio traffic. The Navy Department, represented by Admiral Ziegemeier, indicated that much trouble might come of this double supervision, particularly as practically all Naval stations had to send occasional messages that might be considered "commercial" and therefore would require licenses from the Department of Commerce as well as licensed operators. Secretary Hoover, in replying, said he considered the question more hypothetical than real. He divided the Navy stations' commercial work into the two classes of incidental and, so to speak, cultivated communication; the occasional transmissions could easily be covered by a blanket authority, but he felt that regular transmission of commercial messages must be subject to the same regulation that governs the civilian organizations if an orderly system is to be created.



Before the hearings closed Mr. Hoover and the Secretary of the Navy had conferred on the matter, and Admiral Ziegemeier reported that there seemed nothing to prevent an agreement between the Departments in regard to regulation.

LICENSES AND MONOPOLIES

SECTION 2C of the Bill authorizes the Secretary of Commerce to grant a license "only to a station which is in the interest of the general public service." With the thought that the last three words might be taken with too narrow a meaning, the Telephone company suggested omission of the word "service." This alteration was generally agreed to by those present. The "monopoly clause" in this same section, 2C, which authorizes the Secretary to refuse licenses to any party "monopolizing or seeking to monopolize radio communication, directly or indirectly, through the control of the manufacture or sale of radio apparatus, or by any other means" came in for very little criticism. It was suggested that the wording be limited to "unlawful" monopolies, though Mr. Hoover said he thought no Secretary of Commerce would attempt to set up his own standards as to what constituted a monopoly. Mr. White felt the entire clause might well be omitted, and no one at the hearing seemed disposed to disagree with him.

In section 2F the Secretary of Commerce is given authority to revoke any station license for violation of regulations, etc., and no appeal is provided for. The Telephone company proposed that any order of revocation should state the cause, and that an appeal from such order might be made to the District Court. This amendment was not criticized.

THE ADVISORY COMMITTEE

SECTION 5 of the bill establishes an advisory committee of twelve, comprising a representative from each of the six government departments of War, Navy, State, Agriculture, Commerce, and the Post Office, together with "six members of recognized attainment in radio communication not otherwise employed in the government service." Proponents of the bill expect this committee, which is to consider administration of and changes in the laws and regulations on radio and to correlate the regulations with scientific problems and progress in their solution, to be of great service

to the art in general. Much interest was shown in an amendment proposed by Mr. Maxim, on behalf of the American Radio Relay League, to the effect that none of the six non-governmental members should be "affiliated directly or indirectly in the manufacture, sale, transmission or operation of radio telegraphy or radio telephony for financial profit." Such an amendment would exclude all but amateurs from the non-governmental half of the committee. On this point, Mr. Hoover said that if the wording were made too broad it would make ineligible the technical professions and engineers, and pointed out that present laws prohibit persons "at interest" from accepting government employ. He said he would not like to see the bill embody restrictions that would preclude recognized men of public spirit from appointment on the advisory committee, and this seemed also to be the view of the Congressmen and other witnesses at the hearing.

A number of other amendments were offered on various details, but most of them restated matters already included, either in the bill or in authorizations to the Secretary of Commerce. The proposals of the Radio Corporation of America were contained in a letter which was not read, and consequently are not commented upon in this report. There was no direct opposition to the bill as a whole, however, and there should be little delay in reporting it out of committee for passage by the House of Representatives. It is understood that Mr. White has undertaken to prepare a re-draft embodying such of the proposed amendments as seem to the Committee important enough for inclusion.

Those who attended the hearings were strongly impressed by the interest shown by the Congressmen present. Chairman Greene, Mr. Chindblom, Mr. Davis, Mr. Bankhead, Mr. Bland, and Mr. Hardy all were active in the examination of the witnesses who appeared; it was evident that the Committee intended to give the bill a thorough inspection and revision in the light of the suggestions made at the two-day session. There is no doubt in the minds of those who addressed the Merchant Marine and Fisheries Committee that the bill is in good hands and that, upon its passage, the new powers delegated to Secretary Hoover will result in his clearing the radio art of many of its current difficulties.

Telephoning to England

By R. W. KING

American Telephone & Telegraph Company

THIS is Mr. Thayer of the American Telephone and Telegraph Company speaking from 195 Broadway, New York City through the Rocky Point Station of the Radio Corporation of America."

Ushered in by these words, radio telephone messages were sent from this side of the Atlantic for nearly two hours on Sunday evening, January 14th, and were successfully received at New Southgate, London. Those who listened at New Southgate not only understood every thing that was said by the speakers, but could even recognize the voices of their friends. For the first time in the world's history the two greatest English-speaking countries were joined by the intimate bonds of speech across 3400 miles of water.

This is not the first time that the human voice has been heard across the ocean. In 1915, the telephone engineers sent out messages from Arlington, Virginia. Single words and sometimes sentences were received by other engineers who were listening, some in Paris and some in Honolulu. The present demonstration, however, marks a great advance over that of 1915. Since that time great improvements have been made in the two arts of radio and of telephony. The radio apparatus and system used in this latest test have been made possible by co-operation between the American Telephone and Telegraph Company and the Radio Corporation of America.

The story of preparations for the present transatlantic test is replete with dramatic incidents. On December 1, 1922, J. J. Carty, Vice-President of the American Telephone and Telegraph Company, sent a message to Frank Gill, European Chief Engineer of the Western Electric Company, as fol-

lows: "Planning to send to England engineer with radio receiving set associated with electrical measuring apparatus for determining field strength of received telephone currents transmitted from America." There is little in this matter-of-fact message to stir the imagination or to suggest the brilliant success that was attained just 45 days later. About midnight of the 45th day, after the close of the tests, Carty sent another message to Gill, reading as follows: "Nothing that we could say here could express our complete satisfaction at the results. It does indeed mark an epoch in the history of the telephone and in the history of your country and mine. Tonight, for the first time, they have been joined by the bonds of our common language. Good-night."

Of the many developments since 1915 which have contributed to the demonstration of January 14th, the two most important are a new high-power water-cooled vacuum tube and a new type of radio transmitting system of which the electric wave-filter is an essential part. These water-cooled tubes are used as amplifiers to deliver the 100 K. W. of modulated high-frequency energy to the antenna and also

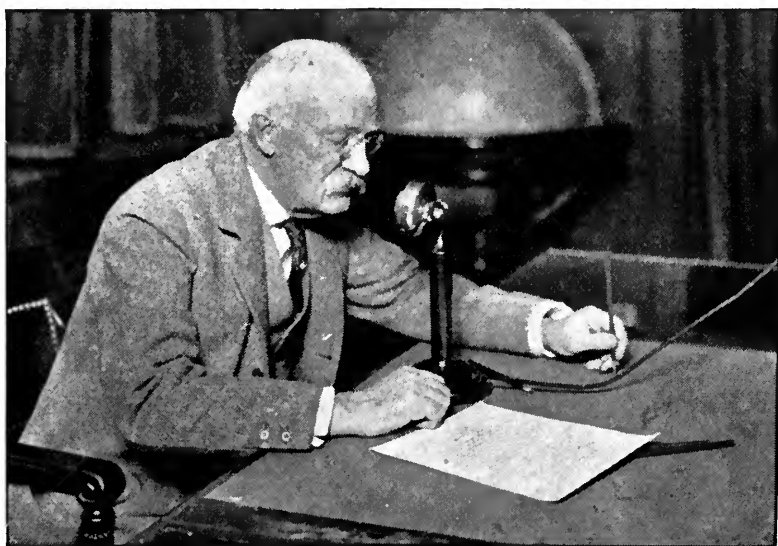

MR. H. B. THAYER TALKING TO LONDON FROM NEW YORK

as rectifiers to produce the high-voltage direct current required to operate the amplifiers.

The series of experiments, of which the tests of January 14th are but a part, will be continued until all the information necessary to the designing of a practical transoceanic telephone system is available. This information pertains largely to the transmission characteristics of the ether which apparently undergoes wide variation from hour to hour, from day to day, and from season to season. It is for this reason that we can not yet speak of telephone service, as we ordinarily understand that term, across the Atlantic. However, the

present experiments are of great significance. In the words of General Carty:

"The experiments which we are now making represent some of the advances which have been made in the first half century of the telephone art, which is now drawing to a close. They belong to the golden age of communication which has achieved the extension of the spoken word throughout both space and time.

"But this golden age has not yet ended, and when we contemplate the possibilities of the future, we discover that it has only just begun. It is to the future that we must now turn our minds and direct our endeavors."

SUPPLEMENTAL LIST OF BROADCASTING STATIONS IN THE UNITED STATES FROM DECEMBER 25
TO JANUARY 13 INCLUSIVE

CALL SIGNAL	OWNER OF STATION	LOCATION
KFAZ	Weatherell, C. H.	Readley, Calif.
KFCM	Richmond Radio Shop	Richmond, Calif.
KFEL	Winner Radio Corp.	Denver, Colo.
KFFJ	Jenkins Furniture Co.	Boise, Idaho
KFFQ	Marksheffel Motor Co.	Colorado Springs, Colo.
WCAE	Kaufmann & Baer Co.	Pittsburg, Pa.
WPAV	Tinetti & Sons, Paul.	Laurium, Mich.
WPAW	Radio Installation Co., Inc.	Wilmington, Del.
WPAX	S—W Radio Co., J. R. Shumate, Jr.	Thomasville, Ga.
WQAC	Gish, E. B.	Amarillo, Texas
WQAE	Moore Radio News Station.	Springfield, Vt.
WQAF	Sandusky Register	Sandusky, Ohio
WQAN	Scranton Times	Scranton, Pa.
WQAY	Gaston Music & Furniture Co.	Hastings, Nebraska
WRAO	Radio Service Co.	St. Louis, Mo.
WSAT	The Plainview Electric Co.	Plainview, Texas

LIST OF BROADCASTING STATIONS DELETED DURING THE MONTH OF DECEMBER

KDYR	Pasadena Star—News Pub. Co.	Pasadena, Cal.
KFBA	Ramey & Bryant Radio Co.	Lewiston, Idaho
KFBJ	Boise Radio Supply Co.	Boise, Idaho
KGF	Pomona Fixture & Wiring Co.	Pomona, Calif.
KYF	Thearle Music Co.	San Diego, Calif.
WAAG	Elliot Elect. Co.	Shreveport, La.
WAAO	Radio Service Co.	Charlestown, W. Va.
WAAR	Groves—Thornton Hardware Co.	Huntington, W. Va.
WAAV	Athens Radio Co.	Athens, Ohio
WCAZ	Compton, Robert E.	Carthage, Ill.
WCJ	Gilbert, The A. C. Co.	New Haven, Conn.
WDAN	Glenwood Radio Corporation,	Shreveport, La.
WFAR	Hall & Stubbs	Sanford, Maine
WIAA	Waupaca Civic & Commerce Ass'n.	Waupaca, Wis.
WJAC	Redell Co., The	Joplin, Mo.
WKAM	Breede, Adam, Hastings Daily Tribune	Hastings, Nebraska
WLAD	Arvanette Radio Supply Co.	Hastings, Neb.
WJAH	Central Park Amusement Co.	Rockford, Ill.
WMC	Columbia Radio Co.	Youngstown, Ohio
WPAN	Levy Bros. Dry Goods Store	Houston, Texas

Another Receiving Contest!

Any Number of Tubes—Any Kind of Receiver

The "How Far Have You Heard On One Tube?" Contest, which closed February 1st, has been a great success. The hundreds of reports, diagrams, questions, and suggestions which we have received indicate the keenest interest in long-distance receiving throughout the country. The final reports of this contest will appear in RADIO BROADCAST for April.

AND—we take pleasure in announcing, owing to the enthusiastic response to this contest, A SECOND LONG-DISTANCE RECEIVING CONTEST, to determine who has done the best with ANY NUMBER OF TUBES AND ANY TYPE OF RECEIVER.

The Four Prizes

First Prize: DE FOREST D-7 REFLEX LOOP RECEIVER

This receiver, described in RADIO BROADCAST for February (page 297), is the latest product of the De Forest Company: it makes three amplifying tubes and a crystal detector do the work of six tubes. The loop antenna aids in selectivity because of its directional properties. An ordinary antenna and ground may be used, however, if desired. Recently, a man in Brooklyn, N. Y. heard a broadcasting station in Seattle, Wash., with one of these sets.

Second Prize: GREBE TUNED RADIO-FREQUENCY AMPLIFIER, TYPE RORN

Illustrated on page 352, RADIO BROADCAST for February. This amplifier, which has a wavelength range of from 150 to 3000 meters, may be used with any form of home-made or bought receiver. It is the most recent development of a company widely known for the excellence in design and workmanship of its products.

Third Prize: Choice of

THREE OF THE NEW RADIOTRON UV-201-A AMPLIFIER TUBES (6 volts, $\frac{1}{4}$ of an ampere), or

THREE AERIOTRON WD-11 DRY-CELL TUBES ($1\frac{1}{2}$ volts, $\frac{1}{4}$ of an ampere).

Fourth Prize: TIMMONS LOUD-SPEAKER UNIT

This unit, which may be connected directly to the output of your amplifier, has a diaphragm adjustable for sounds of different intensities, and when used with two stages of amplification reproduces broadcasted programmes loud enough to fill an average-size room.

Rules of The Contest

1. You should list all broadcasting stations 150 or more miles away from the receiving point, which you have heard distinctly (announcement of location as well as of call letters.)
2. Measure distances accurately, and give aggregate mileage. (This is the sum of all the distances, each station counted once, but two or more stations in the same city being counted separately.) An aggregate mileage of less than 15,000 miles will not be considered.
3. Manuscripts should include the following: description of set, directions or advice for constructing and operating it; any "wrinkles" or makeshifts which you have used to advantage; photograph of your apparatus; circuit diagram; in general, anything you have to tell that will make your story more interesting and helpful. Manuscripts should not be longer than 2000 words. Typewritten reports preferred.
4. Data should be arranged in three columns, under the headings: call letters, location, distance.
5. For material used, a liberal rate will be paid.
6. In judging contributions, the quality and interest of photographs, text, and drawings, and the originality and general effectiveness of the apparatus described, will have greater weight than the list of stations heard, although a long list of distant stations will distinctly help.
7. The Contest begins now and closes May 31st, 1923.
8. Address: Receiving Contest, RADIO BROADCAST, Doubleday, Page & Co., Garden City, N. Y.

How Far Have You Heard on One Tube?

A pretty fair idea of receiving conditions throughout the country may be had from a few minutes' study of the scores in this contest. (Page 436.) Many of the letters from our readers could not be accepted for publication because their aggregate mileage was below 15,000, or because a circuit diagram or at least a mention of the character of circuit employed was omitted.

One of the best descriptions of home-made receivers submitted up to the time of going to press is described below by the designer of it.—THE EDITOR.

A PRACTICAL LONG-RANGE SINGLE-TUBE RECEIVER

How to Build It, and How to Operate It to Best Advantage

By E. V. SEAGER

SOME people enjoy starting at the bottom of radio construction, and, through experiments and improvements, gradually work up to perfection. Others are more interested in the excellent programmes that are continually filling all space, and, while they are interested also in constructing their own set, do not care to take a roundabout way by experimenting, but are desirous of making the best set possible, at the least expense and in the shortest time.

To these last I respectfully submit the following description of a set that will meet their requirements and give them all that can be expected from a single tube. With a like set,

the writer, located in Indianapolis, hears, every evening, stations from Massachusetts to California and from Canada to Cuba.

I shall first give a list of parts needed, and follow with the instructions for constructing and assembling the set:

- $\frac{1}{4}$ pound No. 24 cotton-covered enameled wire
- $\frac{1}{4}$ pound No. 30 cotton-covered enameled wire
- 8 nickel-plated binding posts
- 1 double binding post
- 15 feet No. 18 bare copper wire
- 12 feet spaghetti tubing
- 22 switch points
- 2 switch levers with $1\frac{1}{2}$ -inch arms
- 1 43-plate, vernier condenser with dial
- 2 dials
- 1 Rheostat, vernier preferred
- 1 Tube socket
- 1 UV201 amplifying tube, or one that corresponds to it
- 1 Bezel
- 1 foot flexible wire
- 1 grid condenser, .0005 mfd.
- 1 phone condenser
- $1\frac{1}{2}$ feet brass rod, to fit dials
- 1 large, 22 $\frac{1}{2}$ -volt, variable B Battery
- 1 small, 22 $\frac{1}{2}$ -volt B Battery
- 1 piece wallboard 12 x 24 inches
- 1 6-volt storage battery
- Enough $\frac{1}{4}$ -inch lumber to make cabinet 6 $\frac{1}{2}$ inches high, 8 inches wide, by 24 inches long
- 2 fancy brass hinges
- Enough small, brass wood screws for cabinet
- Small can of varnish stain for cabinet
- Small can black enamel for panel
- A few sheets of tinfoil or leadfoil
- A pair of good phones

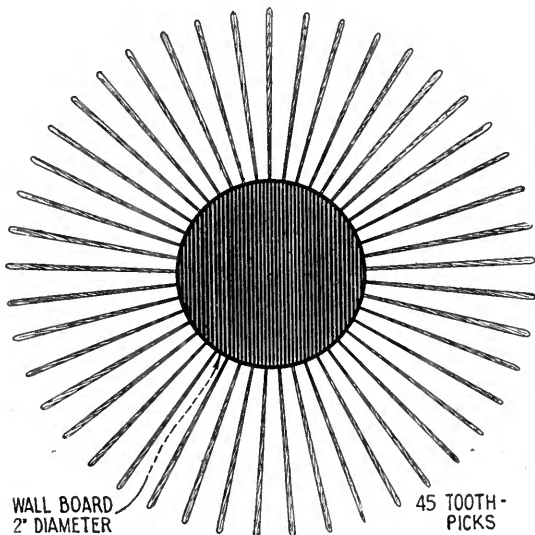

FIG. 1

Form on which coil is wound

First cut two discs 2 inches in diameter from

a piece of wallboard, and mark the rim off into 45 spaces. This can best be accomplished by making a large circle about 6 inches on a piece of paper, placing 45 dots, evenly spaced around the circumference, and drawing lines from the centre to each dot. To space the disc, lay it on the circle in the exact centre and place a mark on the edge where it intersects the lines on the drawing.

Next, stick 45 toothpicks around the edge of each disc, using the marks as guides. Do not push the toothpicks far enough into the disc to split it. These will be a little insecure at first, but when a few turns of wire are wound on, they will be solid. The form will now resemble Figure 1, and is ready for winding.

Before winding wire on the form, it may be easier for some to place the taps on first, as follows:

Unwind the No. 24 wire from the spool, and 16 feet from the end make a tap by taking an 8-inch loop in wire (Fig. 2). Continue measuring off the wire, placing another tap 15 feet from the first one, then one every 10 feet thereafter until there are 4 taps. Cut the wire about 11 feet past the fourth tap.

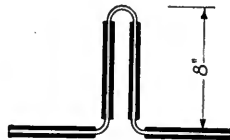

FIG. 2

In making taps, scrape the insulation from the wire next to the base for about $\frac{1}{4}$ inch, and twist the wires together (Fig. 3), after which a little solder should be run on to insure a good contact (at point indicated, Fig. 3). The ends of the loops should also be scraped, where the wire will be soldered to the switch points.

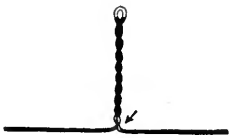

FIG. 3

Now, starting in at the first end, begin weaving the wire back and forth between the toothpicks on the disc, skipping two toothpicks at a time (see Figure 4). Wind to the right and keep all ends and taps to the back of the coil. Continue until the 60 feet of wire are wound on the coil, leaving one foot on the end for a terminal. It is best to secure the coil by taking loop stitches between each toothpick with needle and thread, after which the toothpicks may be cut off flush with the coil. This makes a very neat inductance coil.

The foregoing is a description of the primary

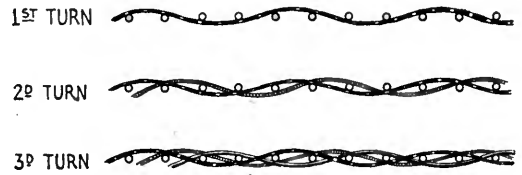

FIG. 4

Winding the coils—over two and under two

coil. The secondary is constructed in the same manner, with the following exceptions:

Use No. 30 wire, and make taps as follows: 15, 30, 40, 50, 60, 70, 80, and 90 feet, leaving one foot on each end. Wind coil to the right and keep ends and loops on *front side*. (Side next to you.)

The next instrument to be constructed is the variometer, which is simply one cardboard cylinder which rotates inside of another larger one, with a continuous winding on both. Obtain a round oatmeal box, having an outside diameter of $4\frac{1}{8}$ inches and cut out a section $2\frac{1}{4}$ inches in width. Punch three or four small holes near the edge of the cylinder and lace No. 24 wire through them, leaving about one foot free. This will secure the wire from slipping while winding. Wind on 50 turns, leaving enough space in the centre of the tube to accommodate the brass rod used for the axle of the rotor.

For the rotor, or inside coil, a salt box having an outside diameter of $3\frac{3}{8}$ inches is about right. Cut out a 2-inch section, as this is all that will turn inside of stator (the large tube). This should be wound the same as the large tube, being careful to wind in the same direction, and leaving space in the centre for the shaft. Wind on all the wire possible in a single layer.

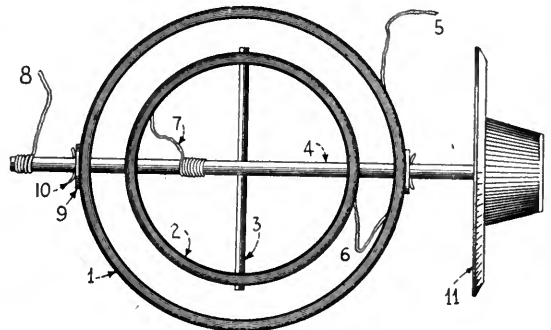

FIG. 5

1—Stator, 2—rotor, 3—rod to secure rotor, 4—shaft, 5—stator terminal to B battery +, 6—continued winding between coils, 7—terminal of rotor soldered to shaft, 8—flexible wire from plate soldered to shaft, 9—Washer, 10—stop pin, 11—dial

Holes should be made in both tubes for the shaft to go through. The best method of doing this is to heat one end of the shaft red-hot and burn them through, which makes the holes the exact size required. Place the rotor inside of large tube and run the rod through both. The rotor should be secured to the shaft so it can be rotated inside the stator. A simple method of doing this is by previously having a small hole drilled in the centre of the rod, and placing a short rod through both tube and shaft (see Figure 5).

The last end of the stator winding should be run through a hole in the stator near the shaft and connected to the beginning of the rotor winding, soldering the connection and winding with adhesive tape. The last end of the rotor winding may be soldered to the shaft, which will then answer for one terminal.

The rod should also be fastened in some manner to prevent slipping back and forth in the stator. This may be accomplished by drilling small holes in the shaft just outside the stator, through which a short piece of rod or wire is inserted as a "stop." It is best to have brass or copper washers between these stops and the tube to bear the wear.

The construction of the cabinet is not difficult, and outside of the general dimensions, it will be left to the builder. For the base use a $\frac{1}{2}$ - or 1-inch board, 8 inches wide by 24 long. The rest of the cabinet should preferably be $\frac{1}{4}$ -inch lumber. This can be procured at small expense by getting a box at the grocery store, which has smooth boards of the required size. By rubbing the boards down and applying a few coats of varnish stain, a very handsome cabinet can be made.

The panel may be made from wallboard, if desired, and if given two coats of black enamel, will very closely resemble hard rubber. It is certainly easier to work, for the amateur who is shy on tools. Of course, if the very best is desired, bakelite or formica is the material to use, but the writer is using a wallboard panel, with absolutely no bad results so far as can be discerned.

All holes in the wallboard panel should be burned through. A tenpenny nail, heated red-hot, is just right for switch-points. Rods can be used for the different sizes on the other holes. There is nothing critical about the measurements for holes, etc. These should be made to accommodate the instrument you are using. The photos will readily give the idea of how things are arranged. Arrange the instruments and design the panel accordingly.

Brass screws should be used in the construction of the cabinet. Never use iron or steel nails. To prevent splitting the thin boards, it is safest to drill or burn a hole first about half the diameter of the screw, and stick the screw itself into a cake of common soap, before inserting it.

As can be seen from a glance at Fig. 9 there should be a partition around the B batteries, vacuum tube, and tuning condenser. These partitions, along with the back of the panel, should be shielded by pasting tinfoil on them. Care must be taken that the shielding does not touch any of the switchpoints, instruments, shafts, etc. It should, however, be connected to the ground.

Binding posts for the aerial, ground, and A battery connections are on back of the cabinet; the aerial is opposite the condenser, the ground

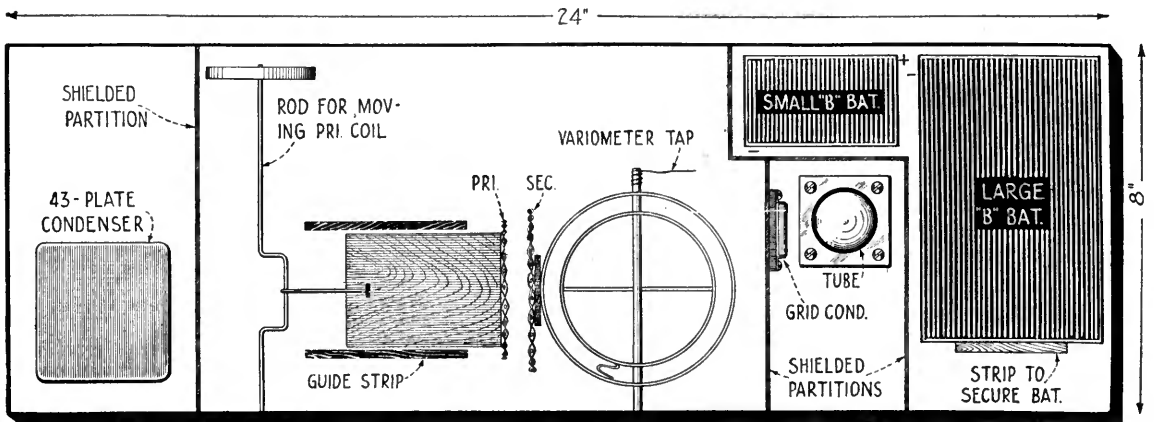

FIG. 6

Arrangement of apparatus within the cabinet

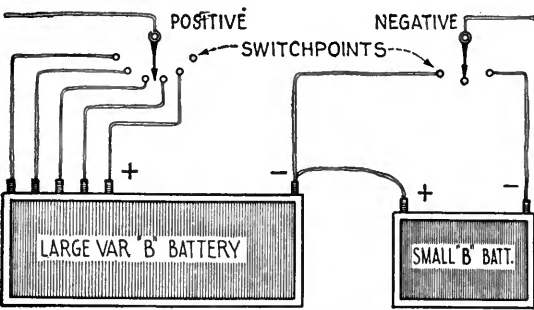

FIG. 7
Method of connecting B batteries

of this set. The hole, through the panel, that accommodates the variometer shaft, should not be burned until after the secondary coil is fastened in place, unless careful calculations are made beforehand.

The stator of the variometer should be placed horizontally (see Fig. 10), with top of cylinder about $\frac{3}{8}$ inch below the centre of the secondary coil, and the winding about $\frac{3}{8}$ to $\frac{1}{2}$ inch from the winding of the secondary. Here is a very important point: current which flows through the stator from the plate of the vacuum tube, must travel in the same direction as the induced current in the secondary, which, if the inductance coils are wound right, would be around the stator to the right, as viewed from above. However, this is best determined after the set has been completed and a trial made to receive signals. All that is necessary to reverse the current is to turn the stator over.

For B battery connections see Figure 7. The two $1\frac{1}{2}$ -inch switch arms, which control the battery currents, are fastened to the panel with small brass machine screws. Put a screw through the switch arm, then run a nut on to the arm and adjust for tension, after which the screw may be put through the panel and another nut screwed on to hold it secure.

Place three switch points on the negative side, having one point in the centre that has no connection. This insures against shorting the

a little past the partition, and the A battery opposite the tube.

The position of the instruments, which may be seen in the diagram (Fig. 6), is as follows: 43-plate, tuning condenser on left, device for moving primary coil to change coupling, primary coil, secondary coil, variometer, tube, and finally, B batteries.

A simple, efficient method of moving the primary coil can be seen in the illustration, and consists of a brass rod, bent in a U shape. Cut a piece of wallboard 1×4 inches and tack one end to the centre of the primary coil and the other to a block of wood, which should be heavy enough to keep the coil upright. Tack guide strips beside block to insure the primary being held parallel to the secondary.

Keeping coils parallel to each other insures uniform induction at all coupling spaces. A strip of wood or metal connects the rod to the coil, so when the rod is turned by the dial, the primary coil may be moved back and forth.

The secondary coil may be secured permanently to the base. Mount the coils so there are no taps between them; in other words, so that the current in the primary and the induced current in the secondary run parallel and in same direction.

We now are ready to set the variometer. This should be very carefully done, as upon its proper installation depends the high efficiency

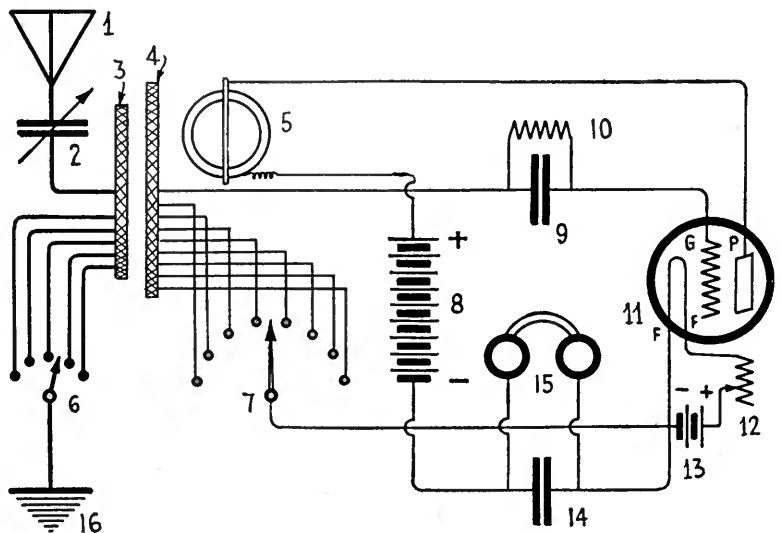

FIG. 8

- 1—Antenna, 2—43-plate condenser with vernier, 3—primary spider-web coil, 4—secondary spider-web coil, 5—variometer, 6—primary switch lever and taps, 7—secondary switch lever and taps, 8—45-volt variable B battery, 9—.0005 grid condenser, 10—grid leak, 11—UV 201 amplifier tube, 12—rheostat, 13—6-volt storage battery, 14—phone condenser, 15—phones, 16—ground

terminals of the battery as well as providing an "off" point, when wishing to disconnect the battery. The switch points on the positive side should be placed far enough apart so that the switch arm cannot touch two at once, which prevents shorting on that side. To do the job in good shape, an "off" point may also be placed at one end.

The phone condenser must be placed between the two phone binding posts (shown at lower right, Fig. 10). The double post, which shows slightly above the two in use in the illustration, is provided for connecting two sets of phones in series, and may be left off if desired.

Near the top of the partition between vacuum tube and variometer, place two binding posts, far enough apart so that the grid condenser can be connected between them.

A suitable grid leak can easily be made by soaking a thread in India ink and, after drying, winding it across the grid condenser binding posts. It is a question for the builder to decide, whether this leak is necessary or not. The set functions perfectly without it. But in case squealing develops, it will help to stabilize the circuit.

All connections should be soldered. Solder the coil and battery taps to switch points before the panel is screwed on, as it will be easier to get at them. However, do not solder the secondary and variometer terminals until after signals are coming in well, as they may have to be reversed. Use No. 18 bare copper wire for internal wiring and cover it with spaghetti tubing.

There is no interference between phone

stations unless they are on exactly the same wavelength. Although the carrier wave can be heard for four or five meters on either side, it is not so strong that it is impossible to hear a station within two meters difference.

Spark stations are more broad, but as a general rule, only those that are close cause much difficulty in reception. Most of them can be almost, if not completely, tuned out by adjusting the coupling and variometer and throwing on a higher plate voltage. All this will change the tuning adjustment, but a little experimenting will teach one how to make up these differences with the tuning condenser.

With a good ground connection, stations can be heard 500 miles without an antenna. In this case the ground should be attached to the aerial binding post. About the same results can be obtained, using the aerial without a ground connection. In this experiment the aerial may be attached either to the aerial binding post or the ground. Local stations can be heard very plainly without either aerial or ground connections. This requires very close tuning and is very directional, so that the set itself will have to be turned until best signals are heard. It also requires all the wire that is in the coils. In this case the coils themselves are the collectors of the radio energy. There are big possibilities in experimenting along these lines.

Purchase the best set of phones obtainable. You will not regret it. There is as much difference in phones as there is in automobiles.

Referring to the photo (Fig. 9), it would seem that there is no attempt made at neatness in wiring. However there is some method in the madness. It is based on the theory that the shortest cut is the best, and, at the same time, it avoids running wires parallel. The beauty of it is that it "percolates" to perfection, so what more could one want?

Just a word about tuning: In first tuning the set, having no idea where the stations should come in, the beginner is liable to tune in on a harmonic wave and not get the best results, although it may be hard to notice any difference in volume.

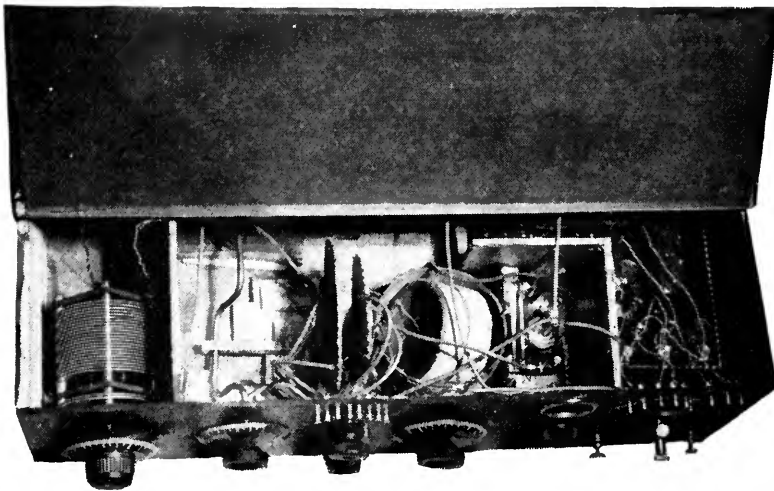

FIG. 9



You can now obtain
CONDENSITE CELORON
RADIO PANELS
 cut in standard sizes

YOU can now get radio panels already cut to a size to fit your needs. For your convenience we are making Condensite Celoron Radio Panels in seven standard sizes. No longer will you have to wait and pay extra cost for having your panel cut to order.

These sizes have been so designed as to meet practically every need of the set-builder. Each panel comes trimmed and wrapped separately in glassine paper to protect the surface. They are all ready for immediate use. On every one are full instructions for working and finishing.

What Condensite Celoron Is

Condensite Celoron is a laminated phenolic condensation product used

by many of the leading manufacturers of radio equipment. It has high insulation resistance, high dielectric strength, low dielectric losses and is easily worked. Because Celoron has these qualities it has received the approval of the U. S. Navy Department Bureau of Engineering and the U. S. Signal Corps.

You can obtain any of these seven standard sizes:

- | | |
|-----------------------------|-------------------------------|
| 1. — 6 x 7 x $\frac{1}{8}$ | 4. — 7 x 18 x $\frac{3}{16}$ |
| 2. — 7 x 9 x $\frac{1}{4}$ | 5. — 9 x 14 x $\frac{3}{16}$ |
| 3. — 7 x 12 x $\frac{1}{8}$ | 6. — 7 x 21 x $\frac{3}{16}$ |
| | 7. — 12 x 14 x $\frac{3}{16}$ |

Select the size you need for your set. If your radio dealer has not yet stocked them, ask him to order for you. Or write direct to us, designating by number the size you want. We can make prompt shipment.

To radio dealers: Write for special dealer price list showing standard assortments

Diamond State Fibre Company

BRIDGEPORT (near Philadelphia) PENNSYLVANIA

BRANCH FACTORIES AND WAREHOUSES
 BOSTON CHICAGO SAN FRANCISCO

Offices in Principal Cities

In Canada: Diamond State Fibre Company of Canada, Limited, 245 Carlaw Avenue, Toronto

CONDENSITE
CELORON
 STANDARD RADIO PANEL

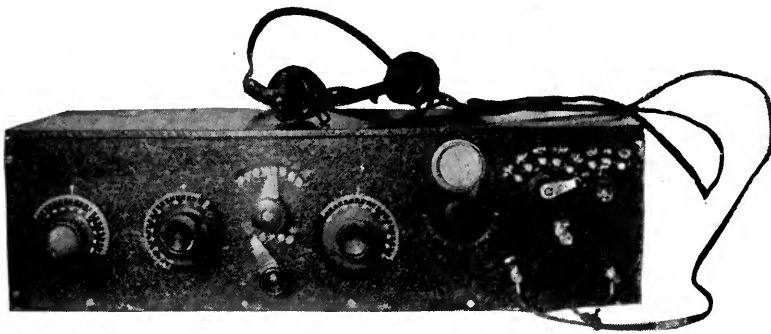

FIG. 10

The panel, made of wall-board, is given two coats of black enamel

It must be borne in mind that different aerials have different natural wavelengths, which affect the setting of the dials, but the following procedure should put you in the right neighborhood of the desired signals:

Set the variometer so that rotor lies in same direction as the stator, with the current flowing in the same direction in both coils. A mark should be made at the top of dial and dial set on rod so that either "0" or "100" is on the mark. Now turn stator about 35 spaces and leave it in this position.

Set the coils about 10 spaces, or $\frac{3}{4}$ of an inch apart. Set the secondary switch arm on the sixth point, or 75 feet. Set the primary switch arm on the second point, or 30 feet. Set the tuning condenser with the moving plates turned out from the stationary plates about 80 spaces. Set the B battery switch at $16\frac{1}{2}$ volts. The set now will be in resonance with a radio wave under 360 meters, when the tube is lighted.

THE GREAT MOMENT

WE HAVE now reached the point of greatest moment in a radio bug's career: the lighting of the tube. The next few moments will disclose whether you are an embryo genius, or merely human. If the former, one of the greatest marvels of the times is about to be revealed with the mere turning on of the rheostat. But if you are merely human—well, we all make mistakes, and it may be that you will have to do a little adjusting before having the pleasure of listening-in.

Turn the rheostat until there is a frying noise in the phones, which will be about $\frac{2}{3}$ of the way around (on the resistance wire wound type of rheostat). If turned too far, the tube will set up a howling in the phones. It should be turned down just below this. You are now ready to locate a station.

Set the B battery switch on 21 volts, after which the tube may have to be turned down some. Turn tuning condenser slowly toward the point where moving plates are enmeshed in the stationary ones. This is raising the wavelength of the set. Soon a high whistle will be heard in the phones, which gets lower as the condenser is turned slowly. After reaching a low point, it will start

rising again, until it passes out of the range of the ear. The correct place to hear the station is between the two low points, which can be brought into adjustment with the vernier on the condenser, or by rotating the variometer slightly.

As the condenser is turned, the variometer can also be turned occasionally until, with the condenser plates entirely enmeshed, the variometer coils should be parallel, with dial reading "0" or "100," whichever the case may be. The set is then in the neighborhood of 400 meters.

If, when the tube is lighted, the set refuses to bring in a sound, assuming that the storage battery leads, aerial and ground are connected to the proper binding posts, the chances are that one of two things are wrong: the terminals of the secondary coil may have to be reversed, or the stator of the variometer probably needs to be turned over to reverse current in relation to secondary. It is possible that both would need adjusting. When proper positions are found, all unsoldered connections should be soldered.

I hope that with the above description and diagrams, the very beginner in radio work will have no difficulty in constructing a set that he will be proud of. There is nothing so enjoyable as to be able to tune in about any station desired, which can be done if records are kept of dial settings, etc. The air is constantly full of good entertainment. I have stayed up until three o'clock in the morning waiting for the last dog to die, and finally had to give up.

With this set, I have heard (from Indianapolis, Ind.) the following stations:

CFCA, CJCG, DN₄, KDKA, KHJ, KLZ, KNJ, KSD, KYW, ₁XAC, ₂XI, NOF, WAAB, WAAC, WAAO, WAAP, WAAZ, WAAV, WBAH, WBAY, WBAP, WBAV, WBL, WBT, WBZ, WCAE, WCM, WCX, WCAS, WDAF, WDAJ, WDAP, WDAV, WEAB, WEAJ, WEAV, WEAY, WFAA, WFAT, WGF, WGR, WGM, WGY, WFAV;

This
combination
completes any
RADIO
RECEIVING SET



MAGNAVOX
Radio

*The Power Amplifier
and Reproducer Supreme*



R-2 Magnavox Radio with 18-inch horn: this instrument is intended for those who wish the utmost in amplifying power; for large audiences, dance halls, etc.

R-3 Magnavox Radio with 14-inch horn: the ideal instrument for use in homes, offices, amateur stations, etc.

Model C Magnavox Power Amplifier insures getting the largest possible power input for your Magnavox Radio. 2 and 3 stage.

When you purchase a Magnavox product you possess an instrument of the highest quality and service.

Magnavox products can be had of good dealers everywhere. Write us for copy of new illustrated booklet.

THE Magnavox, in amplifying with extreme sensitiveness every signal supplied to it from the receiver, must necessarily amplify any extraneous sounds which may originate in the receiver or power amplifier itself.

Therefore, the combination of Magnavox Reproducer with Magnavox Power Amplifier (as illustrated) is very desirable. By this equipment, in connection with a good receiver, you get the music or speech with true clearness—and in practically any volume required.

To own a good receiving set without Magnavox equipment, is like having your house properly wired and then using only small, feeble candle-power lamps in the sockets!

The Magnavox Co., Oakland, California
New York: 370 Seventh Avenue

WHAE, WHAS, WHAZ, WHB, WHK, WIAO, WIAR, WIP, WJAE, WJAF, WJAP, WJAX, WJD, WJZ, WJAN, WKN, WKG, WLAG, WLAL, WLK, WMAB, WMAC, WMAK, WMAH, WMAQ, WMAV, WMAF, WMAT, WMH, WNAC, WNAD, WNAF, WOAI, WOH, WOC, WOR,

WOS, WOI, WOO, WPA, WPAD, WSB, WSY, WWJ, KOP, PWX.

In the "How Far Have You Heard Contest," this represents a distance of about 52,000 miles.

SUMMARY OF RESULTS OBTAINED BY OTHER ENTRANTS WHOSE RECORDS HAVE NOT BEEN PUBLISHED PREVIOUSLY

SINGLE-CIRCUIT REGENERATORS

NAME AND ADDRESS	NO. OF STATIONS	NEAREST STATION	FARTHEST STATION	AGGREGATE MILEAGE
W. E. Davison, Berwick, N. S.	52	460	3045	55,565
Leland Whitelock, Petersburg, Indiana	99	162	1771	52,334
Frank Williams, East Cleveland, O.	79	150	2200	50,635
Neal G. Barnard, Detroit, Minnesota	80	150	1380	47,194
Allan S. Harvey, Snohomish, Wash.	45	415	2000	46,305
H. R. Anderson, Twin Falls, Idaho.	57	185	2080	44,670
J. Edwin Wilson, Frankfort, Ky.	81	175	1150	44,435
M. C. Ridenour, Kingwood, West Va.	78	155	2260	43,280
Harry L. Van Brunt, Council Bluffs, Iowa	52	425	1350	41,725
Calvin C. Cooper, Dufur, Oregon	60	150	2500	40,850
Raymond Smith, Ladoga, Indiana	59	160	2200	35,515
Louis Delhotel, Riverbank, Calif.	18	1500	2500	34,300
H. Holm, Preston, Ontario	61	150	1450	34,073
Frederick E. Croxton, Columbus, O.	66	150	1285	33,995
W. F. Fennell, Saltsburg, Pa.	57	175	2030	31,768
Francis S. Beeler, Hamilton, O.	48	210	1800	31,525
D. W. Longfellow, Elk River, Minn.	42	200	1500	30,630
Richard B. Barker, Newport News, Va.	35	225	1275	30,470
Gerard Curtiss, Wauwatosa, Wis.	44	150	2400	29,550
Phillip W. Patterson, Two Harbors, Minn.	35	150	1200	29,500
Teddy Conrad, Montrose, Mo.	59	150	1100	29,110
D. M. Osborne, Kansas City, Mo.	49	150	1450	28,720
Glen Gately, Rifle, Colo.	42	160	1700	27,815
G. W. Burkhardt, Montebello, Calif.	31	150	1800	27,225
Harold A. Kirk, Tama, Iowa	56	175	1400	27,090
Glenn E. Smith, Germantown, O.	41	250	2300	26,640
Milton D. Satterlee, Quilcene, Wash.	32	165	1650	26,305
Merle Schulling, Beaumont, Calif.	29	300	2512	26,237
R. W. Edmonds, Lancaster, Ohio	48	150	2100	25,865
Philip N. Enigh, Indian Creek, Pa.	39	200	1575	25,688
Lewis M. Ripley, Glastonbury, Conn.	41	180	1530	25,440
Goodwin Compton, Harrisburg, Pa.	44	205	1275	23,325
A. E. Herman, Mexia, Texas	33	150	1350	23,150
A. D. Turnbull, Sydney, N. S.	18	600	2325	22,500
Harry Leeper, Monongah, W. Va.	48	150	1690	22,275
Norman C. Theobald, Attleboro, Mass.	25	375	2000	21,525
Sam Zimerman, Port Lavaca, Texas	21	600	1500	21,515
E. T. Sealey, Donna, Texas	26	270	1750	20,525
Merrill Firestone, Middletown, Pa.	26	350	1295	20,045
F. W. Brenchley, Carbondale, Pa.	37	150	1200	19,920
Walter Kramer, Chicago, Illinois	35	183	2075	19,730
Arthur L. Carlson, Prairie City, Oregon	30	170	1950	19,518
Charles Adams, Algona, Iowa	26	285	1090	19,148
Albert P. Cook, Pittsburgh, Pa.	38	150	1500	18,905
H. P. House, Rensselaer, Indiana	35	190	1840	18,720
I. Potter Lynch, Glens Falls, N. Y.	30	200	1500	18,455
Ray C. Poulson, Detroit, Mich.	35	150	1200	17,865
H. R. Grasskopf, San Antonio, Texas	16	600	1800	17,250
Raymond A. Riedner, Republic, Wash.	28	170	1490	17,225
Walter L. Slater, La Center, Wash.	22	150	3000	17,200
W. F. Neukirch, Chicago, Illinois	26	150	2000	16,905
George Eberhardt, Newark, N. J.	32	150	1375	16,540
Ainsworth Moore, Spiro, Okla.	35	220	1230	16,450
Herbert Snow, Jenks, Okla.	24	225	1300	16,380
Clark C. Radinor, Florence, Mass.	27	175	1500	16,110
Robert D. Shaver, Bay City, Mich.	27	225	875	16,075
H. B. Hunter, Detroit, Mich.	30	200	1025	15,605

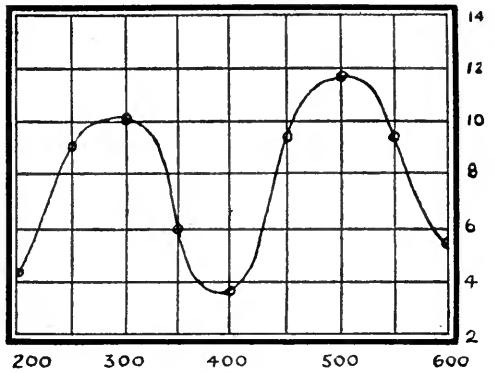
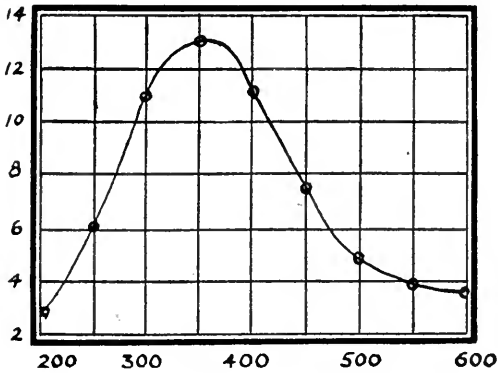

How to get distant stations clearly

Why the Acme Radio Frequency Transformers eliminate distance and distortion

BEFORE you purchase a radio frequency amplifying transformer find out if it has marked depressions and peaks in its amplification range between 250 and 500 meters (indicating absence of amplification in the depressions)—or whether the amplification range curve is uniform.

A Test

THE two charts above tell a graphic story of tests made on radio frequency transformers in the laboratories of a well known concern. The chart at the left plots the amplification range curve of 12 Acme R-2's taken from stock. (Note: The Acme R-2's are made with a special iron core and windings.) The chart at the right represents a composite plot of the curves of 6 ordinary types of different makes taken from stock. The superiority of the Acme R-2 is self evident. Note its steadily increasing amplification curve with its maximum at 360 meters—just where it is most needed.

Better results—greater distance

TO HEAR the distant station is not enough. To understand them—to be entertained by them—that is the real thrill. The Acme R-2 used in a radio frequency amplifier builds up wave energy without distortion before passing it on to the detector. Even the simplest and most elementary types of set, either

vacuum tube or crystal receiver type will have its useful range tremendously increased when the Acme R-2 and a vacuum tube are employed.

The best method

TO GET the distant stations clearly, use Acme Radio and Audio Frequency Amplification. This insures maximum sensitivity and intensity, quietness in operation and freedom from distortion. A small indoor antenna or loop may be used and sufficient intensity obtained to operate the Acme Kleerspeaker providing perfect entertainment for a roomful of people.



Acme R-2 Radio Frequency Amplifying Transformer. Price \$5. (East of Rocky Mountains.)

You can get these and other Acme Products at radio, electrical and many hardware stores. Write for booklet R-2 showing proper hook-ups and other information.

The Acme Apparatus Company

(Pioneer transformer and radio engineers and manufacturers.)

CAMBRIDGE, MASS., U. S. A.

New York, 1270 Broadway
Chicago, 184 W. Washington Street

ACME ~ for amplification

VARIOMETER REGENERATORS

NAME AND ADDRESS	NO. OF STATIONS	NEAREST STATION	FARTHEST STATION	AGGREGATE MILEAGE
Duane D. Karges, Wichita Falls, Texas	99	170	2100	64,160
D. C. McBride, Winchester, Tenn.	74	150	1875	44,355
Mrs. John H. Patterson, Harrisonville, Mo.	60	175	1525	34,286
H. N. Walker, Detroit, Mich.	72	200	2000	33,180
R. V. Hammer, Creston, Iowa.	57	150	1450	32,920
Ralph B. Ritter, Milwaukee, Wis.	47	200	1800	29,800
Raymond G. Miller, Evansville, Ind.	49	160	1700	29,125
Edmund Howard, Waterbury, Conn.	43	150	1575	27,925
Raymond Cartwright, Sharpsville, Pa.	58	150	1160	27,385
Otto C. Steinberger, Vicksburg, Mich.	52	152	1475	27,114
H. H. Nicholson, Rural Valley, Pa.	37	185	1502	25,418
R. M. Blain, Galt, Ontario	37	300	2200	24,880
Earl M. Polk, Dayton, Ohio	46	150	1200	24,785
George A. Istok, Pittsburgh, Pa.	34	225	2330	23,135
Alvin T. Harrison, Spring Valley, Minn.	38	160	1010	22,590
Laurence Dean, Petaluma, Calif.	22	400	2000	22,190
P. C. Mayfield, Oberbrook Boro., Pa.	47	195	1235	21,980
Edwin Hines, Hayward, Wis.	29	450	1050	21,605
A. C. Van der Bent, Philadelphia, Pa.	35	150	1700	21,560
William B. Gibson, Connellsville, Pa.	47	160	1350	21,135
Henry H. Wilson, Paterson, N. J.	32	150	1470	20,960
Harold Pike, Fairgrove, Mich.	39	165	1175	20,565
Charles N. Alexander, Sioux Falls, S. D.	31	345	1380	20,419
M. L. Halcum, Imboden, Arkansas	27	300	1400	18,050
Cecil Newton, Webster, N. Y.	37	190	1425	17,140
Clifford Lauer, W. Philadelphia, Pa.	35	150	1350	15,375

STANDARD REGENERATORS

Garlon Tice, Marshfield, Wis.	56	150	1650	35,265
Harold Ingledue, Guthrie Center, Iowa	55	150	1250	34,510
Ralph Ray, Newburgh, N. Y.	55	150	1890	32,339
Hodge Eaton, Carbondale, Illinois.	60	150	1200	31,665
G. O. Wilkinson, Philadelphia, Pa.	59	150	1240	29,770
M. A. Poulk, Oil Hill, Kansas	45	150	1425	28,580
G. E. Pike, Toronto, Ontario	51	150	1350	25,900
M. J. Cleary, North Sydney, Nova Scotia	28	550	2100	25,375
Bernard Johnson, Moorhead, Minn.	35	230	1350	25,310
Robert Paxton, Troy, N. Y.	27	200	1450	17,227
Seton Scott, Owen Sound, Ontario	33	175	1260	17,141
Hugh Quick, Manitou, Colo.	25	400	1500	15,600

WESTINGHOUSE "RC" RECEIVERS

Frank H. Jones, Tuinucu, Cuba.	47	200	1600	59,025
Dixon M. Meuller, New York City	20	150	1700	16,990

NON-REGENERATIVE RECEIVERS

S. U. Tymeson, So. Lancaster, Mass.	41	150	1550	25,300
-------------------------------------	----	-----	------	--------

SINGLE-TUBE LOOP CIRCUIT

H. Lardner, Halifax, N. S.	18	550	1800	15,225
----------------------------	----	-----	------	--------

CLAPP-EASTHAM "HR" REGENERATIVE RECEIVER

George S. De Lisle, Kansas City, Mo.	38	150	1350	20,330
--------------------------------------	----	-----	------	--------

SINGLE TUBE SUPER-REGENERATOR

Charles H. Byrnham, Newtonville, Mass.	31	150	2620	20,082
---	----	-----	------	--------

REINARTZ CIRCUIT

A. O. Rowe, Detroit, Michigan.	45	275	1535	26,680
--------------------------------	----	-----	------	--------